

Installation Instructions

NPDBL-24DDFK

Surface Mount Kit for 2' x 4' LED Backlit Panels with Emergency

READ PRIOR TO ATTEMPTING INSTALLATION
ALWAYS TURN OFF MAIN POWER BEFORE INSTALLATION
INSTALLATION SHOULD BE CARRIED OUT BY YOUR LOCAL ELECTRICIAN

⚠ IMPORTANT - This equipment is intended to be installed only by qualified personnel. The installation must be made in accordance with the current edition of the National Electrical Code and all applicable state and local building codes. The final installation must be approved by the appropriate, qualified electrical/building inspector(s). Improper installation may result in a fire or electrical hazard. Be sure the electrical power to the circuit has been disconnected before installing this electrical system.

⚠ IMPORTANT - Cet équipement est destiné à être installé uniquement par du personnel qualifié. L'installation doit être faite conformément à l'édition actuelle du Code national de l'électricité et à tous les codes de construction locaux et nationaux applicables. L'installation finale doit être approuvée par un ou plusieurs inspecteurs qualifiés en électricité / bâtiment. Une installation incorrecte peut entraîner un incendie ou un risque électrique. Assurez-vous que l'alimentation électrique du circuit a été déconnectée avant d'installer ce système électrique.

INSTALLATION INSTRUCTIONS

1. Turn all power off before installation.
2. Assemble three frames together with (6) screws of surface mount frame.
3. Install three connected frames on the ceiling with (6) long screws and plastic anchors (if needed).
(Note: Junction box or conduit should be located near the panel's junction box)
4. Remove LED panel's (ordered separately) desired knockout and connect panel's wires to input.
5. Insert the panel into the three connected frames and attach the fourth frame with (6) screws.



PACKAGING CONTENTS

- (4) Frames
- (12) Screws to assemble surface mount frame
- (6) Long screws for ceiling mount
- (6) Plastic anchors

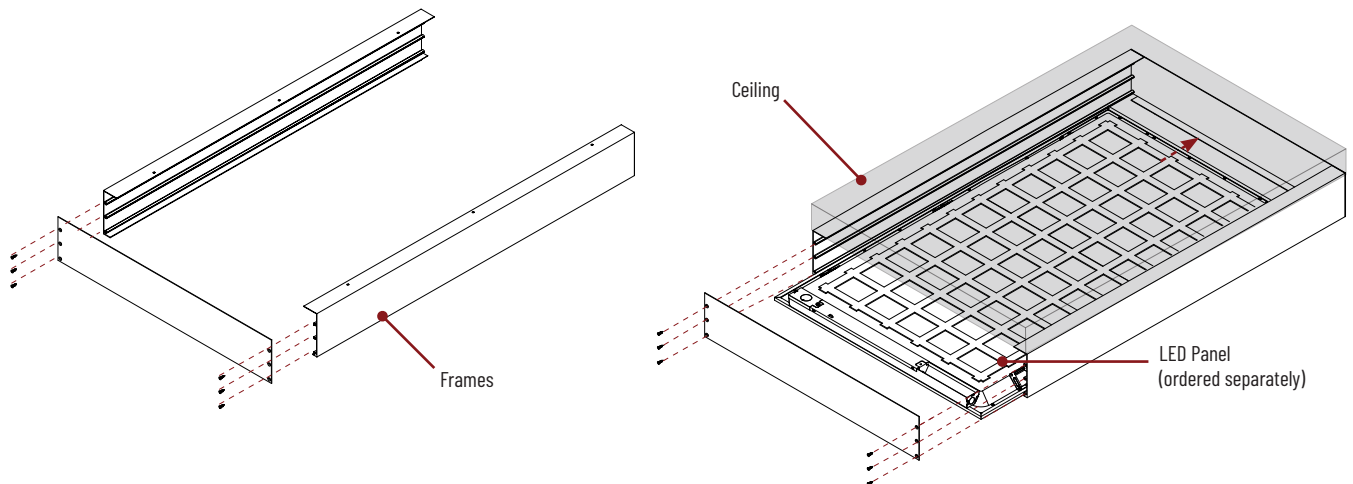

PENDANT MOUNT INSTALLATION

1. Turn all power off before installation.
2. Assemble three frames together with (6) screws (included with surface mount kit).
3. Attach the aircraft cables to the surface mount frame with screws (included with pendant kit).
(Note: 2' x 4' panels require six cables)
4. Cut power cable to desired length (Note: leave extra length for wiring and adjustment) and insert aircraft cables through each wire gripper on canopy.
5. Mount canopy's universal bracket to ceiling.
6. Remove desired knockout on panel and connect power cable (included with pendant kit)
7. Insert the panel into the three connected frames and attach the fourth frame with (6) screws.
8. Connect power cable (attached to canopy) to input wires.
9. Secure canopy to the universal bracket mount with (2) finished screws.
10. Adjust the desirable length and level the panel by pressing the wire grippers at the canopy and feed the suspension wires in or out as necessary. Cut excess suspension wires after final adjustment.

REQUIRES: NPD-PK or NPDBL-PK (Ordered Separately)

