

# Installation Instructions

## NM4-RDC

### 4" M4 Round LED Recessed Downlight

**READ PRIOR TO ATTEMPTING INSTALLATION**  
**ALWAYS TURN OFF MAIN POWER BEFORE INSTALLATION**  
**INSTALLATION SHOULD BE CARRIED OUT BY YOUR LOCAL ELECTRICIAN**

- ⚠ WARNING** - Risk of shock. An electric current can cause painful shock or serious injury unless handled properly. For your safety, always remember to turn off power supply at the fuse or circuit breaker box before you install the fixture and ground the fixture to avoid potential electric shocks and to ensure reliable starting.
- ⚠ WARNING** - Risk of cuts. Some metal parts in the fixture may have sharp edges. To prevent cuts and scrapes, wear gloves when handling the parts.
- ⚠ IMPORTANT** - This equipment is intended to be installed only by qualified personnel. The installation must be made in accordance with the current edition to the National Electric Code and all applicable state and local building codes. The final installation must be approved by the appropriate qualified electrical/building inspector(s). Improper installation may result in a fire or electrical hazard. Be sure the electrical power to the circuit has been disconnected before installing this electrical system.
- ⚠ AVERTISSEMENT** - Risque de choc. Un courant électrique peut causer des chocs douloureux. Pour votre sécurité, vérifiez l'alimentation du boîtier de disjoncteur avant d'installer le projecteur et de le mettre à la terre pour éviter tout risque choc et assurer un démarrage fiable.
- ⚠ AVERTISSEMENT** - Risque de coupure. Certaines pièces métalliques de l'appareil peuvent avoir des arêtes vives. Pour éviter les coupures et les éraflures, portez des gants lors de la manipulation des pièces.
- ⚠ IMPORTANT** - Cet équipement est destiné à être installé uniquement par du personnel qualifié. L'installation doit être faite en conformité avec l'édition actuelle du Code national de l'électricité et toutes étatiques et locales codes du bâtiment applicables. L'installation finale doit être approuvée par l'inspecteur en électricité / bâtiment qualifié approprié(s). Une mauvaise installation peut entraîner un incendie ou un risque électrique. Soyez sûr de la puissance électrique vers le circuit a été coupée avant l'installation de ce système électrique.

#### JUNCTION BOX INSTALLATION

##### ⚠ TURN OFF MAIN POWER BEFORE INSTALLATION

1. Make sure power is off.
2. Locate a suitable position to install luminaire and cut a 3-1/2" diameter hole in the ceiling. (Figure 1)
3. Run power supply leads through the hole. Use NMD90 Romex or BX Cable.
4. Open the remote driver box's cover and remove the appropriate knockouts.
5. Insert power supply leads through the knockout and secure with a cable connector. (not included)
6. Using push-in connectors, connect the same colored power supply lead wires to the fixture wires. (Figure 2)
7. Place all wiring and connections back into the remote driver box and close the cover.
8. Place junction box through the mounting hole and secure (Figure 3).

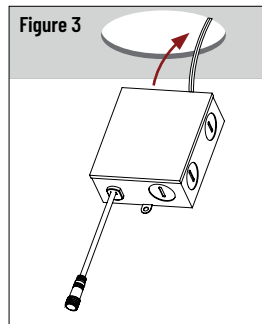
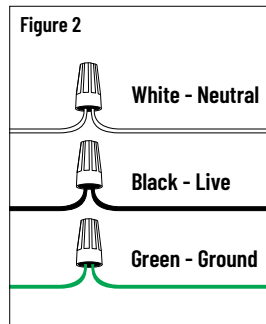
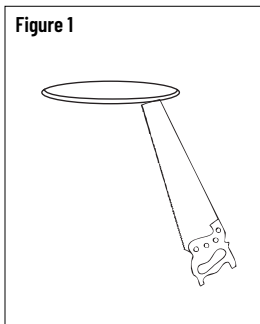

#### LUMINAIRE INSTALLATION

1. Connect the luminaire to the junction box by inserting and twisting the male/female connectors. (Figure 1)
2. Do not place junction box above luminaire. (Figure 2)
3. Push spring loaded clips on the fixture upwards and insert fixture base into the mounting hole. Release the clips and fixture will be pulled flush to the ceiling. (Figure 3)
4. Once assembly is complete, turn on power to confirm fixture is working properly.

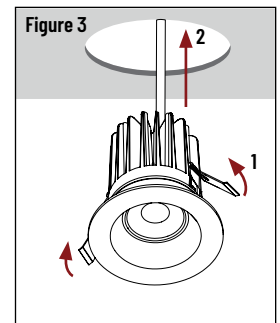
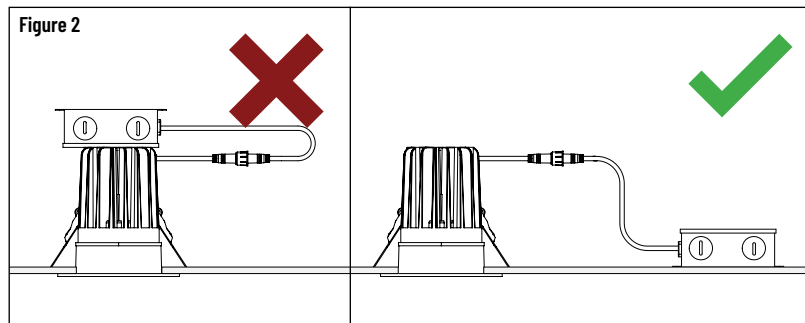
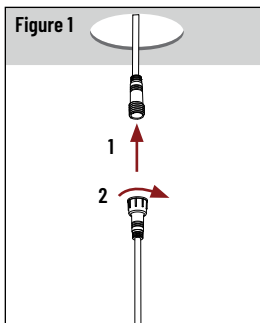

# Installation Instructions

## NM4-RDC

### 4" M4 Round LED Recessed Downlight

READ PRIOR TO ATTEMPTING INSTALLATION  
ALWAYS TURN OFF MAIN POWER BEFORE INSTALLATION  
INSTALLATION SHOULD BE CARRIED OUT BY YOUR LOCAL ELECTRICIAN

#### NEW CONSTRUCTION FRAME-IN INSTALLATION

REQUIRES: NMF-3 (Ordered Separately)

1. Turn off power from the electrical panel before starting installation.
2. Adjust the hanger bars to the desired length.
3. Secure new construction frame-in into joist. Adjust the frame-in to the desired location. (Figure 1)
4. Cut a 3-<sup>3</sup>/<sub>4</sub>" diameter hole in ceiling through center of frame-in.
5. Run power supply leads through the ceiling cut out.

Figure 1

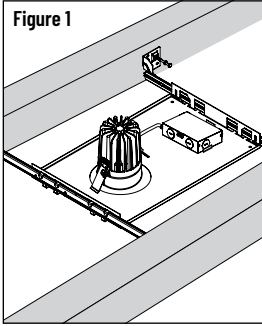

#### SQUARE TRIM INSTALLATION

REQUIRES: NM4-SDT (Ordered Separately)

1. Turn off power from the electrical panel. If installed, remove from ceiling.
2. Remove trim by turning counter clockwise to unlock. (Figure 1)
3. Attach square trim and turn clockwise to lock. (Figure 2)
4. Connect fixture to the junction box by inserting and twisting male/female connectors. (Figure 3)
5. Reinstall fixture and turn on power to confirm fixture is working properly. (Figure 4)

Figure 1

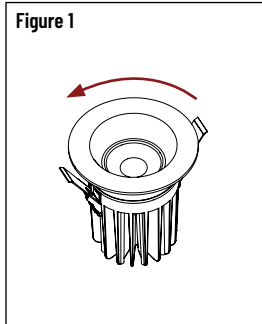

Figure 2

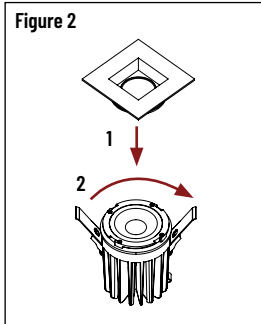

Figure 3

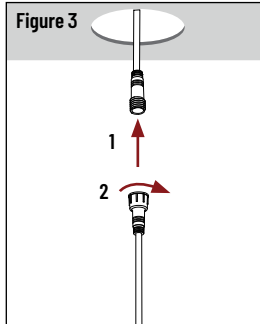

Figure 4

