

Installation Instructions

NLOPAC2-R6509T24

6" AC Opal - LED Surface Mount

READ PRIOR TO ATTEMPTING INSTALLATION
ALWAYS TURN OFF MAIN POWER BEFORE INSTALLATION
INSTALLATION SHOULD BE CARRIED OUT BY YOUR LOCAL ELECTRICIAN

⚠ WARNING - Do not make or alter any open holes in an enclosure of wiring or electrical components during kit installation.

⚠ AVERTISSEMENT - Il est interdit de faire ou de modifier une ouverture dans un boîtier de câblage ou de composants électriques au cours de l'installation du nécessaire.

⚠ WARNING - To prevent wiring damage or abrasion, do not expose wiring to edges of sheet metal or other sharp objects.

⚠ AVERTISSEMENT - Afin de prévenir l'endommagement ou l'abrasion des câbles, éviter tout contact entre ces derniers et le bord d'un objet tranchant tel qu'une tôle.

• This product must be installed in accordance with the applicable installation code by a person familiar with the construction and operation of the product and the hazards involved.

• Ce produit doit être installé selon le code d'installation pertinent, par une personne qui connaît bien le produit et son fonctionnement ainsi que les risques inhérents

⚠ RISK OF FIRE OR ELECTRIC SHOCK. LED Retrofit Kit Installation requires knowledge of luminaires electrical systems. If not qualified, do not attempt installation. Contact a qualified electrician.

⚠ RISQUE D'INCENDIE OU DE CHOC ÉLECTRIQUE. L'installation de ce nécessaire de modernisation exige une personne familière avec la construction et le fonctionnement du système électrique du luminaire et des risques associés. Toute personne qui n'est pas qualifiée ne doit faire aucune tentative d'installation et doit contacter un électricien qualifié.

⚠ RISK OF FIRE OR ELECTRIC SHOCK. Install this kit only in the luminaires that has the construction features and dimensions shown in the photographs and/or drawings and where the input rating of the retrofit kit does not exceed the input rating of the luminaire.

⚠ RISQUE D'INCENDIE OU DE CHOC ÉLECTRIQUE. N'installer ce nécessaire que dans les luminaires dont les caractéristiques de construction et les dimensions sont conforme a celles illustrées dans les photo et/ou les dessins et dont la puissance d'entrée nominale du nécessaire de modernisation ne dépasse pas celle du luminaire.

• This retrofit kit is accepted as a component of a luminaire where the suitability of the combination shall be determined by authorities having jurisdiction.

• Le nécessaire de modernisation est accepté a titre de composant d'un luminaire autorités competentes.



PACKAGING CONTENTS

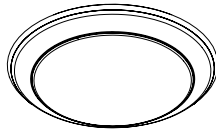

(1) LED Luminaire

For Retrofit Installation:

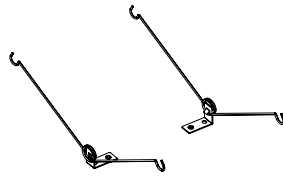

(2) Retrofit Brackets

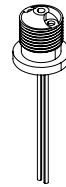

(1) Medium Base Socket Adapter

For Surface Mount Installation:

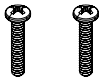

(2) 6-32 Machine Screws
0.75" long



(1) LED Lamp Replacement Marking Sticker



(2) 8-32 Machine Screws
0.25" long

COMPATIBLE JUNCTION BOXES

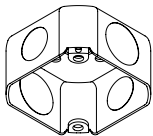

3" Octagonal Junction Box

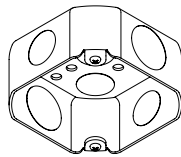

4" Octagonal Junction Box
Metallic or Non-Metallic
(Carlson A615)

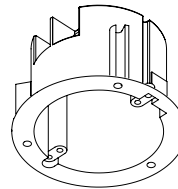

4" Round Non-Metallic
(Carlson B620)

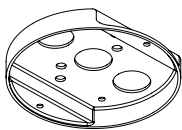

4" Pancake Junction Box

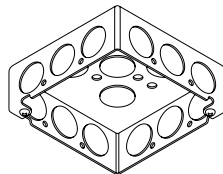

4" Square Junction Box

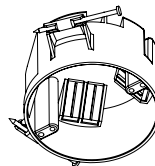

4" Round Non-Metallic
(Carlson B618R)



HOUSING DIMENSIONS

Min. Diameter	Min. Height	Max. number of 12AWG through branch wiring
6" (153mm)	5.5" (139mm)	8
5.3" (134mm)	6" (153mm)	8

Install this kit only in luminaires that have the construction features and dimensions described in these instructions, and where the input rating of the retrofit kit does not exceed the input rating of the luminaire.

Installation Instructions

NLOPAC2-R6509T24

6" AC Opal - LED Surface Mount

READ PRIOR TO ATTEMPTING INSTALLATION
ALWAYS TURN OFF MAIN POWER BEFORE INSTALLATION
INSTALLATION SHOULD BE CARRIED OUT BY YOUR LOCAL ELECTRICIAN

SURFACE MOUNT INSTALLATION

- 1** Twist the diffuser counterclockwise to detach from luminaire.

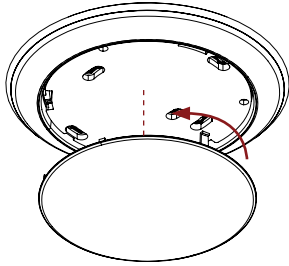

- 2** Connect luminaire to supply leads. Remove appropriate labels and install luminaire to junction box by two screws (provided) through the appropriate mounting holes.

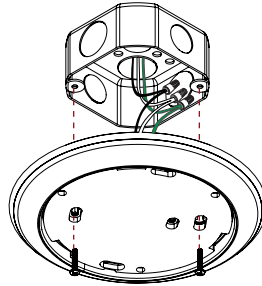

NOTE: Mounting holes are labeled for use with compatible junction boxes.
NOTE: Do not over torque screws. Over torquing screws will deform luminaire.

- 3** Twist the diffuser clockwise to attach the luminaire to complete installation.

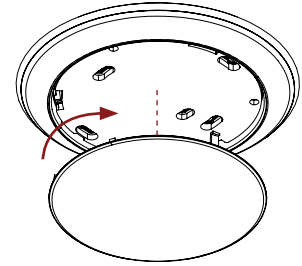

RETROFIT INSTALLATION

- 1** Twist the diffuser counterclockwise to detach from luminaire.

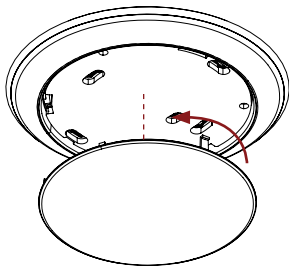

- 2** Attach retrofit brackets to the luminaire by using (2) machine screws to the mounting holes **marked for retrofit kit**. Twist diffuser clockwise to attach to the luminaire.

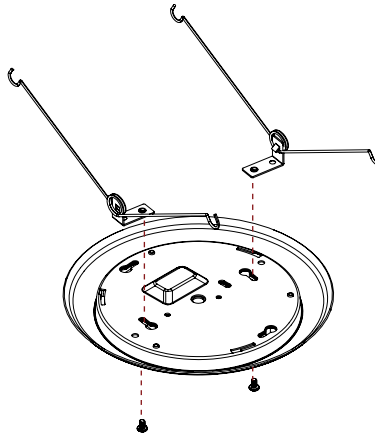

- 3** Place LED Lamp Replacement marking sticker (provided) inside the housing.

Connect luminaire supply leads with medium base socket adapter leads with wire nuts (provided).

Screw medium base socket adapter (provided) to housing's socket and insert luminaire into housing to complete installation.

