

NORA<sup>®</sup>  
LIGHTING

**N** CONTRACTOR  
SERIES



## TABLE OF CONTENTS

Can-less LED Downlights  
with Deep Reflector ..... Pg. 6

Can-less LED Wafer Downlights  
with Regressed Baffle ..... Pg. 8

LED Retrofit Downlights .....Pg. 10

LED Flush Mount Disk Lights .....Pg. 12

LED Backlit Panels .....Pg. 14

Quick Ship Program .....Pg. 16



Nora Lighting is a family owned business since 1989. Our product options range from recessed, commercial, track, under-cabinet, tape, accent, multiples, linear, cylinders, strip, exit and emergency.

Scan for more info.



Visit our  
**Contractor Series  
Webpage**

[www.noralighting.com/contractor](http://www.noralighting.com/contractor)

Contact our **Distributor**



Scan to locate  
your nearest distributor





## Simple to Stock

Eliminate SKUs with the most popular styles of products, all with Selectable CCT.

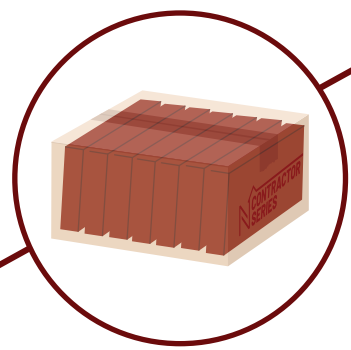

## Bulk Packed = Less Waste

Fewer boxes and instruction sheets to dispose of on your job site.



## Quick Ship

Items eligible for Nora's New Quick Ship Program!



# NORA<sup>®</sup> LIGHTING

Today, contractors are purchasing sub-par products because of aggressive price points only to have upset end users and frustrated distributors when product lacked quality and performance.

Nora Lighting recognized the need to bridge the gap between price and quality, and the Nora Contractor Series was our answer. The Nora Contractor Series product line-up is concentrated on everyday distributor stocking items that are specifically designed to ensure an exceptional value to the contractor without a sacrificing quality product.

These items ship quickly, are bulk packaged to eliminate waste and provide multiple SKUs in one item with selectable CCT - making them an ideal choice for busy contractors and distributors alike.

Nora Lighting leveraged its over 35-year history in designing and manufacturing high quality LED and non-LED residential and commercial lighting to bring this series to light. Our humble beginnings as a company are at the core of how we make choices and how we operate and thrive as a business. This enables us to listen and provide the right product to meet the needs of distribution.

At Nora Lighting we stand by our product and our company's mantra of:

***Large enough to do it right, small enough to care.***

# CONTRACTOR SERIES

## Can-less LED Downlights

<b>BULK PACK</b>	12 per box	
<b>SIZE</b>	4"	6"
<b>LUMENS / WATTAGE</b>	850lm / 10W	1050lm / 12W



**NCSC-R4D1TWMPW**



**NCSC-R6D1TWMPW**

## Can-less LED Wafer Downlights

<b>BULK PACK</b>	12 per box	
<b>SIZE</b>	4"	6"
<b>LUMENS / WATTAGE</b>	750lm / 10W	1050lm / 13.5W

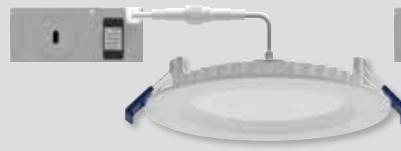

**NCSC-R4W2TWMPW**



**NCSC-R6W2TWMPW**

## LED Retrofit

<b>BULK PACK</b>	12 per box	
<b>SIZE</b>	4"	6"
<b>LUMENS / WATTAGE</b>	700lm / 10W	950lm / 12W



**NCSR-R41TWMPW**



**NCSR-R61TWMPW**

## Surface Mount

<b>BULK PACK</b>	12 per box	
<b>SIZE</b>	6"	
<b>LUMENS / WATTAGE</b>	1200lm / 16W	



**NCSD-R6TWMPW**  
(Selectable CCT)



**NCSR-R630MPW**  
(Dedicated 3000K)

## LED Backlit Panels

<b>BULK PACK</b>	4 per box	
<b>SIZE</b>	2' x 2'	2' x 4'
<b>LUMENS / WATTAGE</b>	3700lm / 30W	5700lm / 45W



**NCSP-22/334W**



**NCSP-24/334W**

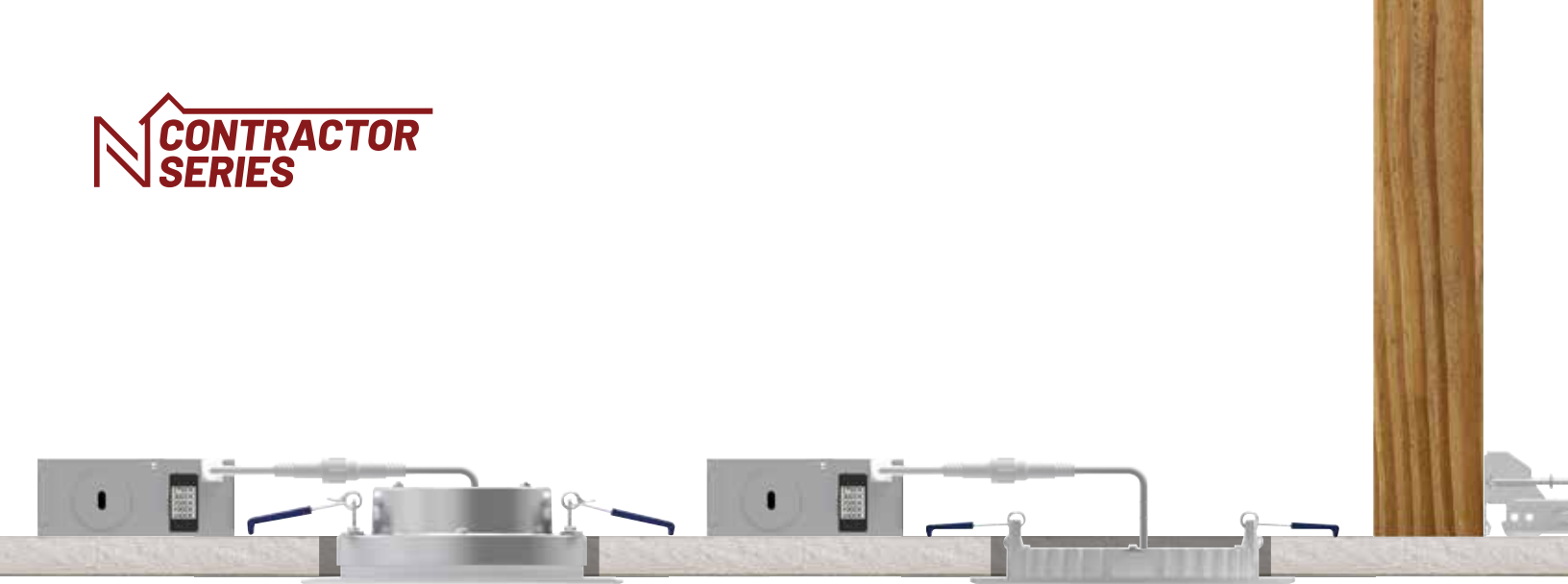

**NCSC-RD**

4" & 6" CAN-LESS LED DOWNLIGHTS

**CASE QUANTITY:  
12 PCS**

PART NUMBER	NCSC-R4D1	NCSC-R6D1
INPUT VOLTAGE	120VAC	
WATTAGE	10W	12W
LUMENS	850lm	1050lm
DIMMING	Triac or ELV	
CRI	90+ CRI	
COLOR TEMPERATURE	Selectable CCT	

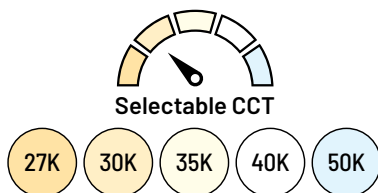

**NCSC-RW**

4" & 6" CAN-LESS LED WAFER DOWNLIGHTS

**CASE QUANTITY:  
12 PCS**

PART NUMBER	NCSC-R4W2	NCSC-R6W2
INPUT VOLTAGE	120VAC	
WATTAGE	10W	13.5W
LUMENS	750lm	1050lm
DIMMING	Triac or ELV	
CRI	90+ CRI	
COLOR TEMPERATURE	Selectable CCT	

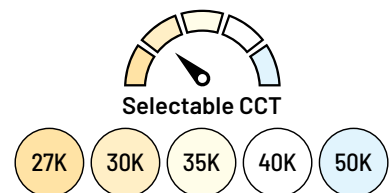

# DOWNLIGHTS

Can-less, Retrofit & Surface Mount



## NCSR

4" & 6" LED RETROFIT DOWNLIGHTS

CASE QUANTITY:  
**12 PCS**

PART NUMBER	NCSR-R41	NCSR-R61
INPUT VOLTAGE	120VAC	
WATTAGE	10W	12W
LUMENS	700lm	950lm
DIMMING	Triac or ELV	
CRI	90+ CRI	
COLOR TEMPERATURE	Selectable CCT	

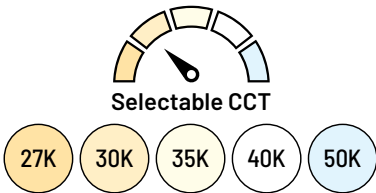

## NCSD

6" LED FLUSH MOUNT DISK LIGHT

CASE QUANTITY:  
**12 PCS**

PART NUMBER	NCSD-R6TW	NCSD-R630
INPUT VOLTAGE	120VAC	
WATTAGE	16W	
LUMENS	1050lm	
DIMMING	Triac or ELV	
CRI	90+ CRI	
COLOR TEMPERATURE	Dedicated 3000K	

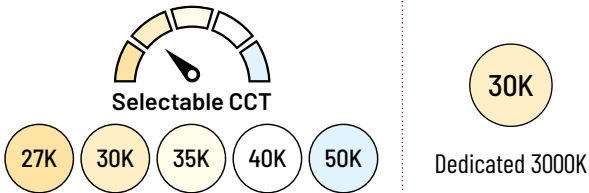



## NCSC-R4D / NCSC-R6D

4" & 6" CAN-LESS LED DOWNLIGHTS WITH DEEP REFLECTOR

Can-less LED recessed downlights are designed for easy installation into new construction or remodel applications. Each downlight includes an Selectable CCT switch located on the junction box. Deep reflector provides excellent glare control, quality of light, and efficiency.



**NCSC-R6D1TWMPW**  
1050lm / 12W

**NCSC-R4D1TWMPW**  
850lm / 10W







Scan for more info.



**NCSC-R4D1**



**NCSC-R6D1**

Scan for more info.

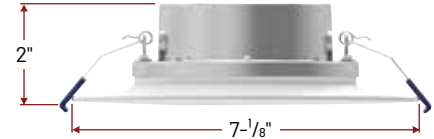
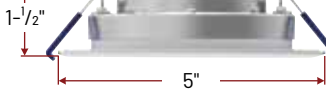
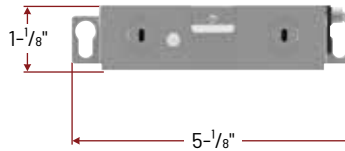

PART NUMBER	NCSC-R4D1	NCSC-R6D1
INPUT VOLTAGE	120VAC	
WATTAGE	10W	12W
LUMENS	850lm	1050lm
BEAM SPREAD	100° Flood	
DIMMING	Triac or ELV	
CRI	90+ CRI	
COLOR TEMPERATURE		

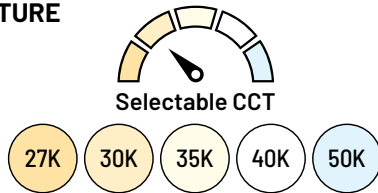

**FEATURES:**

- Deep cone reflector with dead front trim
- No housing required and includes pre-wired junction box
- Quick installation and cost savings
- Dimmable to 10%
- Five color temperature switch on remote driver
- IC rated for direct contact with insulation
- Air-Tight rated for energy savings
- cETLus listed for wet locations
- Mounting accessories and battery back up available
- 5-Year limited warranty



**ACCESSORIES**

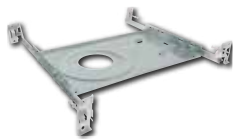

Universal New Construction Frame-In for 4" Downlight only  
**NF-R246**

New construction frame-in can be used to assist installing can-less recessed downlighting. Helps indicate wiring location and cutting guide.



New Construction Frame-In with Collar for 4" Downlight  
**NFC-R430**

New construction frame-in can be used to assist installing can-less recessed downlighting.



New Construction Frame-In with Collar for 6" Downlight  
**NFC-R55**

New construction frame-in can be used to assist installing can-less recessed downlighting.



Emergency Battery with Remote Test Switch  
**NEPK-20LEDUNV**

120-277V Emergency battery operates luminaire for 90 minute emergency operation with a fully charged battery. Requires 24 hours to for full charge.



Quick Connect Extension Linkable Cables  
**NEFLINTW-EW-4** 4' Cable  
**NEFLINTW-EW-20** 10' Cable

Use to extend the length between luminaire and driver enclosure.

**4" & 6" CAN-LESS LED DOWNLIGHT WITH DEEP REFLECTOR**

CATALOG NUMBER	UPC	DESCRIPTION	LUMENS / WATTAGE	CASE QTY.
<b>NCSC-R4D1TWMPW</b>	732180816804	4" Can-less LED Downlight with Deep Reflector	850lm / 10W	12 PCS.
<b>NCSC-R6D1TWMPW</b>	732180816811	6" Can-less LED Downlight with Deep Reflector	1050lm / 12W	12 PCS.



## NCSC-R4W / NCSC-R6W

4" & 6" CAN-LESS LED WAFER DOWNLIGHTS WITH REGRESSED BAFFLE

Can-less LED recessed downlights are designed for easy installation into new construction or remodel applications with low ceiling plenum. Each downlight includes an Selectable CCT switch located on the junction box. Regressed baffle provides glare control and improved quality of light.



**NCSC-R6W2TWMPW**  
1050lm / 13.5W

**NCSC-R4W2TWMPW**  
750lm / 10W



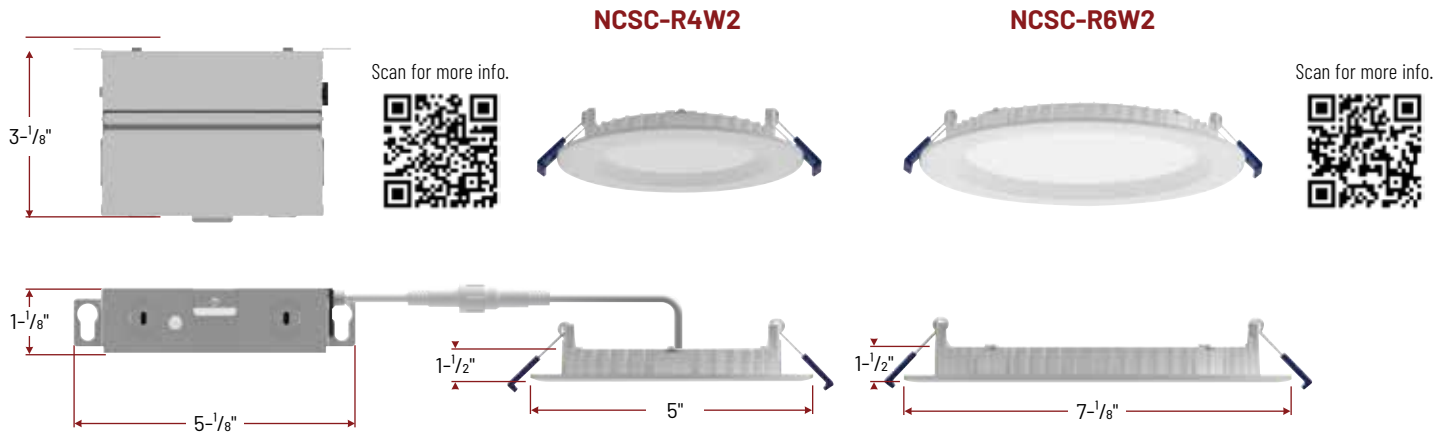

PART NUMBER	NCSC-R4W2	NCSC-R6W2
INPUT VOLTAGE	120VAC	
WATTAGE	10W	13.5W
LUMENS	750lm	1050lm
BEAM SPREAD	112° Flood	
DIMMING	Triac or ELV	
CRI	90+ CRI	
COLOR TEMPERATURE		

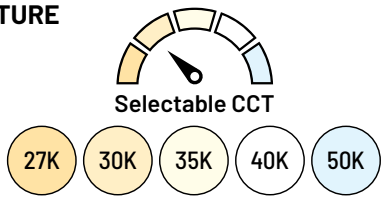

- FEATURES:**
- Only 5/8" tall, ideal for shallow plenums
  - No housing required and includes pre-wired junction box
  - Quick installation and cost savings
  - Dimmable to 10%
  - Five color temperature switch on remote driver
  - IC rated for direct contact with insulation
  - Air-Tight rated for energy savings
  - cETLus listed for wet locations
  - Mounting accessories and battery back up available
  - 5-Year limited warranty



**ACCESSORIES**

<p><b>NF-R246</b> Universal New Construction Frame-In for 4" &amp; 6" Downlights New construction frame-in can be used to assist installing can-less recessed downlighting. Helps indicate wiring location and cutting guide.</p>	<p><b>NFC-R430</b> New Construction Frame-In with Collar for 4" Downlight New construction frame-in can be used to assist installing can-less recessed downlighting.</p>	<p><b>NQZ-6R-F</b> New Construction Frame-In with Collar for 6" Downlight New construction frame-in can be used to assist installing can-less recessed downlighting.</p>	<p><b>NEPK-20LEDUNV</b> Emergency Battery with Remote Test Switch 120-277V Emergency battery operates luminaire for 90 minute emergency operation with a fully charged battery. Requires 24 hours to for full charge.</p>	<p><b>NEFLINTW-EW-4</b> 4' Cable <b>NEFLINTW-EW-20</b> 10' Cable Use to extend the length between luminaire and driver enclosure.</p>
---	--	--	---	---

**4" & 6" CAN-LESS LED WAFER DOWNLIGHT WITH REGRESSED BAFFLE**

CATALOG NUMBER	UPC	DESCRIPTION	LUMENS / WATTAGE	CASE QTY.
NCSC-R4W2TWMPW	732180816842	4" Can-less LED Wafer Downlight with Regressed Baffle	750lm / 10W	12 PCS.
NCSC-R6W2TWMPW	732180816859	6" Can-less LED Wafer Downlight with Regressed Baffle	1050lm / 13.5W	12 PCS.



## 4" & 6" IC AIR-TIGHT HOUSINGS

PART NUMBER	UPC	DESCRIPTION	CASE QTY.
<b>NS-401QAT/IC</b>	732180607907	4" IC Air-Tight New Construction w/ Medium Base Socket	6 PCS.
<b>NHIC-17QAT</b>	732180615568	6" IC Air-Tight New Construction w/ Medium Base Socket	6 PCS.
<b>NSRIC-404QAT</b>	732180402458	4" IC Air-Tight Remodel w/ Medium Base Socket	6 PCS.
<b>NHRIC-17QAT</b>	732180615605	6" IC Air-Tight Remodel w/ Medium Base Socket	6 PCS.

## NCSR-R41 / NCSR-R61

4" & 6" LED RETROFIT REFLECTOR WITH SELECTABLE CCT

LED retrofit downlights are designed for easy installation into existing, new construction or remodel housings. Each downlight includes an Selectable CCT switch located on the back. Deep reflector provides excellent glare control, quality of light, and efficiency.

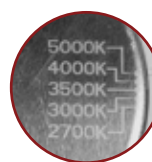

**NCSR-R61TWMPW**  
950lm / 12W



**NCSR-R41TWMPW**  
700lm / 10W



### NCSR-R41

Scan for more info.



### NCSR-R61

Scan for more info.

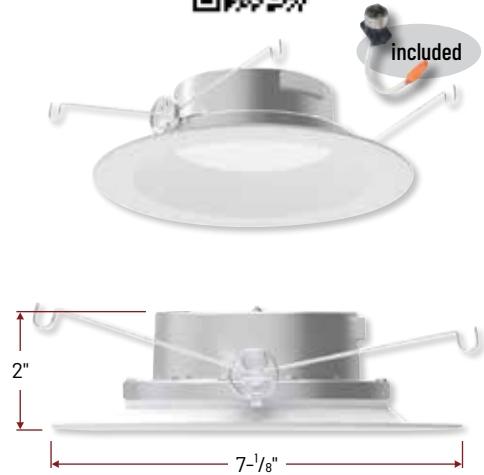

PART NUMBER	NCSR-R41	NCSR-R61
INPUT VOLTAGE	120VAC	
WATTAGE	10W	12W
LUMENS	750lm	950lm
BEAM SPREAD	99° Flood	
DIMMING	Triac or ELV	
CRI	90+ CRI	
COLOR TEMPERATURE	Selectable CCT	

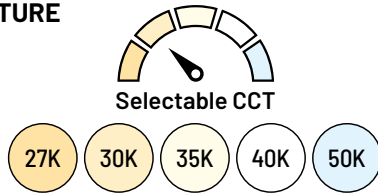

#### FEATURES:

- Up to 2" height, fits over standard or shallow housings
- Plastic dead-front reflector trim
- Deep regressed reflector with matte power white finish
- Medium base socket adapter included
- Quick installation and cost savings
- Dimmable to 10%
- Five color temperature switch on the back of luminaire
- Gasket included for Air-Tight rating and energy savings
- cETLus listed for wet locations
- Certified to CA Title 24 JA8 requirements
- 5-Year limited warranty



## 4" & 6" LED RETROFIT REFLECTOR

CATALOG NUMBER	UPC	DESCRIPTION	LUMENS / WATTAGE	CASE QTY.
NCSR-R41TWMPW	732180816804	4" LED Retrofit Reflector with Selectable CCT	700lm / 10W	12 PCS.
NCSR-R61TWMPW	732180816811	6" LED Retrofit Reflector with Selectable CCT	950lm / 12W	12 PCS.



## NCSD-R6

6" LED FLUSH MOUNT DISK LIGHT

Sleek, low-profile LED flush mount downlights are designed for easy installation over junction boxes. Available in dedicated 3000K or Five Selectable CCTs. Provides general illumination in residential and commercial applications including hospitality and multi-family.



**NCSD-R630MPW** (3000K)  
**NCSD-R6TWMPW** (5 CCT)  
 1200lm / 16W



**Selectable CCT**  
 Five position switch  
 27K / 30K / 35K / 40K / 50K



**NCSD-R6TW**

**NCSD-R630**

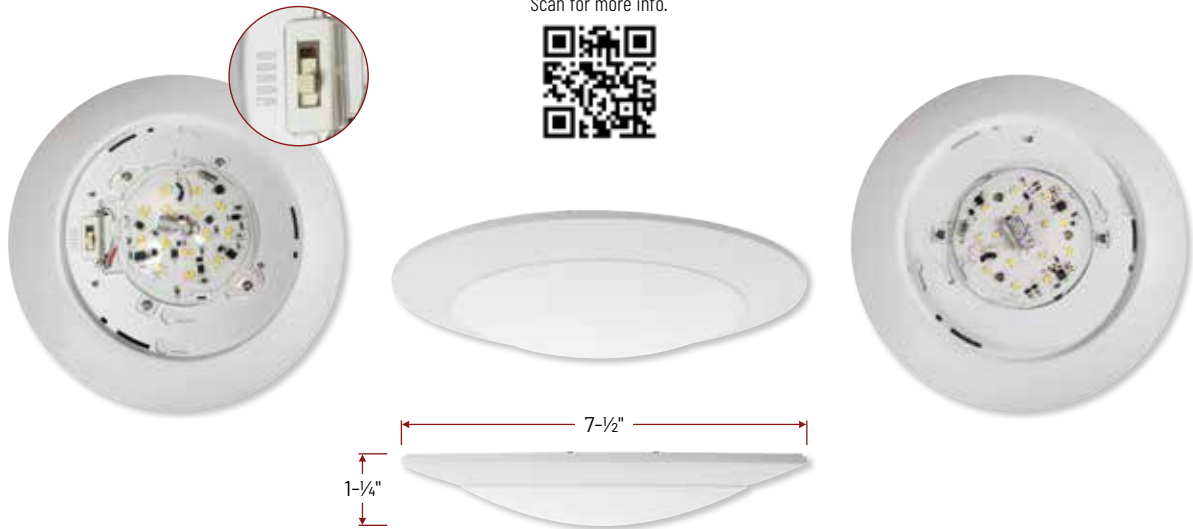

<b>PART NUMBER</b>	<b>NCSD-R6TW</b>	<b>NCSD-R630</b>
<b>INPUT VOLTAGE</b>	120VAC	
<b>WATTAGE</b>	16W	
<b>LUMENS</b>	1200lm	
<b>BEAM SPREAD</b>	112° Flood	
<b>DIMMING</b>	Triac or ELV	
<b>CRI</b>	90+ CRI	

**COLOR TEMPERATURE**

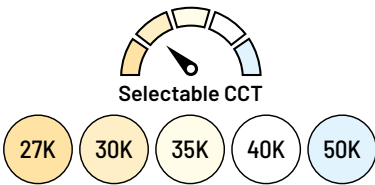

**30K**  
Dedicated 3000K

**FEATURES:**

- Only 1-1/4" height and 7-1/2" diameter
- Easy installation over standard junction boxes
- Quick installation and cost savings
- Delivering over 1200 lumens @ 16W
- Dimmable to 10%
- Available in Dedicated 3000K or Selectable CCT
- cETLus listed for wet locations
- Certified to CA Title 24 JA8 requirements
- 5-Year limited warranty



**6" LED FLUSH MOUNT DISK LIGHT**

CATALOG NUMBER	UPC	DESCRIPTION	LUMENS / WATTAGE	CASE QTY.
<b>NCSD-R6TWPW</b>	732180816880	6" LED Flush Mount Disk Light with Selectable CCT	1200lm / 16W	12 PCS.
<b>NCSD-R630MPW</b>	732180816897	6" LED Flush Mount Disk Light with Dedicated 3000K CCT	1200lm / 16W	12 PCS.



## NCSP

LED BACKLIT PANELS WITH SELECTABLE LUMENS & SELECTABLE CCT

Sleek, low-profile LED flush mount downlights are designed for easy installation over junction boxes. Available in dedicated 3000K or Five Selectable CCTs. Provides general illumination in residential and commercial applications including hospitality and multi-family.

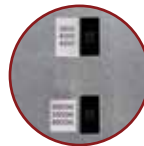

**NCSP-22/334W**  
3700lm / 30W

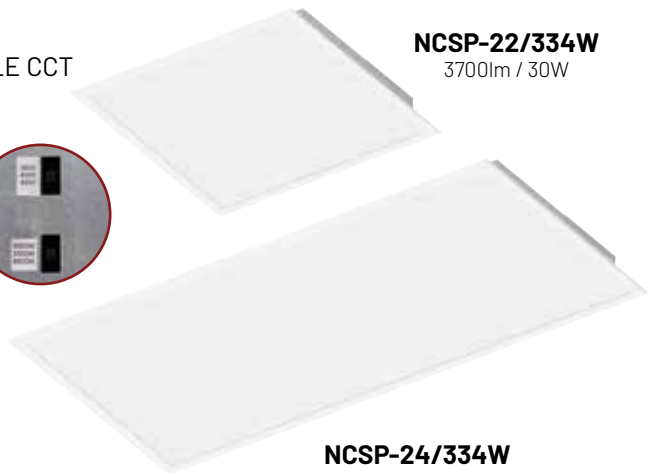

**NCSP-24/334W**  
5700lm / 45W



Scan for more info.



**NCSP-22/334W**

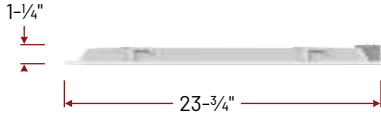

**NCSP-24/334W**

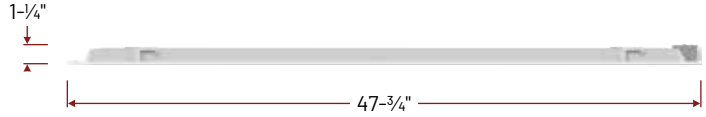

Scan for more info.



<b>PART NUMBER</b>	<b>NCSP-22/334W</b>	<b>NCSP-24/334W</b>
<b>INPUT VOLTAGE</b>	120-277VAC	
<b>WATTAGE</b>	20W / 25W / 30W	35W / 40W / 45W
<b>LUMENS</b>	2600lm / 3100lm / 3700lm	4700lm / 5200lm / 5700lm
<b>DIMMING</b>	0-10V	
<b>CRI</b>	80+ CRI	
<b>COLOR TEMPERATURE</b>		

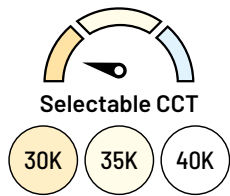

**FEATURES:**

- Only 1-1/4" tall, perfect for drop-in ceilings
- Smooth even lens projects a clean and crisp aesthetic
- Quick installation and cost savings
- Dimmable to 5% with compatible 0-10V dimmers
- Two Selectable Lumen and Color Temperature switches
- IC rated for direct contact with insulation
- Universal 120-277V input
- cETLus listed for damp locations
- DLC listed
- Mounting kits and accessories available
- 5-Year limited warranty



**ACCESSORIES**



**Junction Box for Daisy Chaining**  
**NPDBL-JB4X4**  
Junction box mounts on panel to allow them to be daisy chained together on the same switch (4-in / 4-out)



**Surface Mounting Kit**  
**NPDBL-22DFK/W** 2' x 2'  
**NPDBL-24DFK/W** 2' x 4'  
The frame mounts over an existing junction box and the panel slides into place. Surface mounting frame only extends 2.5" from the ceiling.  
*Note: Junction box must be off center frame.*



**Recessed Mounting Kit**  
**NPDBL-22RFK/W** 2' x 2'  
**NPDBL-24RFK/W** 2' x 4'  
The white finished flange kit consist of one piece. The assembled frame installs into a hard ceiling. The panel lifts and shift in the frame ending in a finished flush appearance.

**LED BACKLIT PANELS WITH SELECTABLE LUMENS & SELECTABLE CCT**

CATALOG NUMBER	UPC	DESCRIPTION	LUMENS / WATTAGE	CASE QTY.
<b>NCSP-22/334W</b>	732180816866	2' x 2' LED Backlit Panel with Selectable Lumens & CCT	Up to 3700lm 20W / 25W / 30W	4 PCS.
<b>NCSP-24/334W</b>	732180816873	2' x 4' LED Backlit Panel with Selectable Lumens & CCT	Up to 5700lm 35W / 40W / 45W	4 PCS.



## QUICK SHIP PROGRAM

Introducing the Nora Quick Ship Program! Our Quick Ship program features SKUs that have the highest demand, along with our entire Contractor Series to meet contractors' everyday needs. Eligible orders placed before 1PM PST ship the same day - ensuring you have a high-quality product exactly when you need it!

*Terms and conditions apply, reach out to your Nora representative today for full details.*



**NHIC-17QAT / NHIC-6LMRAT**  
6" Housing



**NHIC-4LMRAT**  
4" Housing



**NS-401QAT**  
4" Housing



**NSRIC-404QAT**  
4" Housing

## RECESSED HOUSINGS

PART NUMBER	UPC	DESCRIPTION
<b>NHIC-4LMRAT</b>	732180400645	4" LED Dedicated IC Air-Tight New Construction Housing
<b>NS-401QAT</b>	732180403325	4" Non-IC Air-Tight Line Voltage New Construction Housing
<b>NSIC-401QAT</b>	732180403387	4" IC Air-Tight Line Voltage Double Wall New Construction Housing
<b>NSRIC-404QAT</b>	732180402458	4" IC Air-Tight Line Voltage Remodel Housing
<b>NHIC-17QAT</b>	732180615568	6" IC Air-Tight Line Voltage Housing
<b>NHIC-17QNBAT</b>	732180615582	6" IC Air-Tight Line Voltage Housing, No Bracket
<b>NHIC-6LMRAT</b>	732180606214	6" LED Dedicated IC Air-Tight New Construction Housing
<b>NHRIC-17QAT</b>	732180615605	6" IC Air-Tight Line Voltage Remodel Housing



**NTM-713WAL**  
6" White Trim



**NTM-31**  
6" White Trim



**NT-28**  
6" White Trim



**NS-40**  
4" White Trim



**NS-46**  
4" White Trim



**NS-18**  
4" White Trim

## RECESSED TRIMS

PART NUMBER	UPC	DESCRIPTION
<b>NS-18</b>	732180441273	4" Adjustable Eyeball
<b>NS-40</b>	732180441532	4" Stepped Baffle with Ring
<b>NS-46</b>	732180441891	4" Specular White Reflector with Metal Trim
<b>NT-28</b>	732180640270	6" BR30/PAR30 Eyeball with Metal Trim
<b>NTM-31</b>	732180641253	6" BR30/PAR30 White Stepped Baffle with Ring
<b>NTM-713WAL</b>	732180610037	6" BR40/PAR38 Air-Tight Aluminum Baffle Cone with Flange

## OTHER QUICK SHIP ELIGIBLE PRODUCTS



**NX-603D-LED**  
Dual Color Exit Sign  
with Battery Backup



**NE-612LEDW**  
Compact Emergency



**NE-700LEDRC**  
Emergency with Remote Capability

### EXIT & EMERGENCY

PART NUMBER	UPC	DESCRIPTION
<b>NE-612LEDW</b>	732180706457	LED Compact Dual Head Emergency Light
<b>NE-700LEDRCW</b>	732180923335	LED Emergency Light with Remote Capability
<b>NX-603D-LED</b>	732180706570	Dual Color LED Exit Sign with Battery Backup



**NELOCAC-6RP**  
6" ELO Surface Mount  
1080lm / 15W / 3000K



**NSLIM-4RL1TWMPW**  
4" Slim Surface Mount  
with Selectable CCT

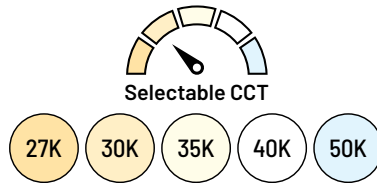

### SURFACE MOUNT

PART NUMBER	UPC	DESCRIPTION
<b>NELOCAC-6RL130W</b>	732180579952	6" ELO LED Surface Moun, 1080lm / 15W, 3000K
<b>NSLIM-4RL1TWMPW</b>	732180834952	4" Slim LED Surface Mount with Selectable CCT

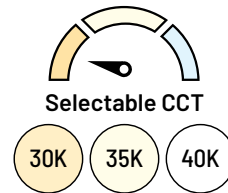
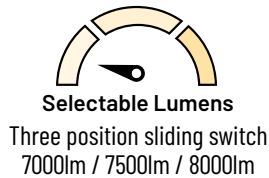

### COMMERCIAL

PART NUMBER	UPC	DESCRIPTION
<b>NLWPSW-4334W</b>	732180580644	48" LED Wraparound with Selectable Lumens & CCT



**NORA LIGHTING, INC.**  
6505 Gayhart St.  
Commerce, CA 90040  
TEL 323.767.2600  
FAX 323.722.3677  
[www.NoraLighting.com](http://www.NoraLighting.com)

**DOMESTIC FACILITIES:**

Atlanta, GA  
Cincinnati, OH  
Dallas, TX  
Detroit, MI  
Edison, NJ  
Los Angeles, CA  
Louisville, KY  
Minneapolis, MN  
Nashville, TN

**INTERNATIONAL SALES:**

6505 Gayhart St.  
Commerce, CA 90040  
TEL 323.767.2600  
FAX 323.722.3677

The products shown in this catalog are covered by USA and International patents. Specifications subject to change without notice.

© Copyright 2024 Nora Lighting, Inc.  
All rights reserved

6M ML-CSC1024

