

# Installation Instructions

## NLOPAC-R7MSTW

### 7" AC Opal LED Surface Mount with Selectable CCT & Motion Sensor

**READ PRIOR TO ATTEMPTING INSTALLATION**  
**ALWAYS TURN OFF MAIN POWER BEFORE INSTALLATION**  
**INSTALLATION SHOULD BE CARRIED OUT BY YOUR LOCAL ELECTRICIAN**

- ⚠ WARNING** - Risk of fire or electric shock. Luminaire wiring and electrical parts may be damaged when drilling for installation of LED retrofit kit. Check for enclosed wiring and components.
- ⚠ AVERTISSEMENT** - Risque d'incendie ou d'électrocution. Le câblage du luminaire et les pièces électriques peuvent être endommagés lors du perçage pour l'installation du kit de rénovation LED. Vérifiez le câblage et les composants inclus.
- ⚠ WARNING** - To prevent wiring damage or abrasion, do not expose wiring to edges of sheet metal or other sharp objects.
- ⚠ AVERTISSEMENT** - Afin de prévenir l'endommagement ou l'abrasion des câbles, éviter tout contact entre ces derniers et le bord d'un objet tranchant tel qu'une tôle.
- This product must be installed in accordance with the applicable installation code by a person familiar with the construction and operation of the product and the hazards involved.
  - Ce produit doit être installé selon le code d'installation pertinent, par une personne qui connaît bien le produit et son fonctionnement ainsi que les risques inhérents
- ⚠ RISK OF FIRE OR ELECTRIC SHOCK.** LED Retrofit Kit Installation requires knowledge of luminaires electrical systems. If not qualified, do not attempt installation. Contact a qualified electrician.

- ⚠ RISQUE D'INCENDIE OU DE CHOC ÉLECTRIQUE.** L'installation de ce nécessaire de modernisation exige une personne familière avec la construction et le fonctionnement du système électrique du luminaire et des risques associés. Toute personne qui n'est pas qualifiée ne doit faire aucune tentative d'installation et doit contacter un électricien qualifié.
- ⚠ RISK OF FIRE OR ELECTRIC SHOCK.** Install this kit only in the luminaires that has the construction features and dimensions shown in the photographs and/or drawings and where the input rating of the retrofit kit does not exceed the input rating of the luminaire.
- ⚠ RISQUE D'INCENDIE OU DE CHOC ÉLECTRIQUE.** N'installer ce nécessaire que dans les luminaires dont les caractéristiques de construction et les dimensions sont conforme a celles illustrees dans les photo et/ou les dessins et dont la puissance d'entree nominale du nécessaire de modernisation ne dépasse pas celle du luminaire.
- This retrofit kit is accepted as a component of a luminaire where the suitability of the combination shall be determined by authorities having jurisdiction.
  - Le nécessaire de modernisation est accepté a titre de composant d'un luminaire autorites competentes.



#### PACKAGING CONTENTS

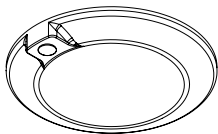

(1) LED Luminaire



(3) Wire Nuts, Twist-Lock



(2) 6-32 Machine Screws

#### COMPATIBLE JUNCTION BOXES

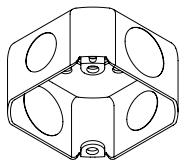

3" Octagonal Junction Box

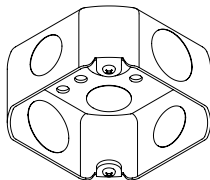

4" Octagonal Junction Box

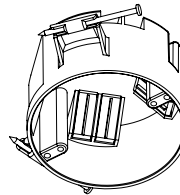

4" Plastic Round

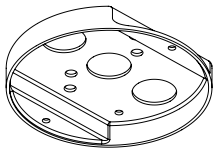

4" Pancake Junction Box

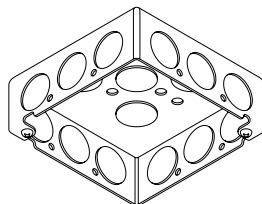

4" Square Junction Box

# Installation Instructions

## NLOPAC-R7MSTW

### 7" AC Opal LED Surface Mount with Selectable CCT & Motion Sensor

READ PRIOR TO ATTEMPTING INSTALLATION  
ALWAYS TURN OFF MAIN POWER BEFORE INSTALLATION  
INSTALLATION SHOULD BE CARRIED OUT BY YOUR LOCAL ELECTRICIAN

#### JUNCTION BOX INSTALLATION

REQUIRES: NLOPAC-4BKT-2 (ORDERED SEPARATELY)

- 1** Select the motion sensor setting by toggling the switch located at the back of the luminaire to the desired setting. **NOTE:** Luminaire is preset at 100% - 50% - Off (Other option is 100% - Off) and may change in shipping / handling / installation.

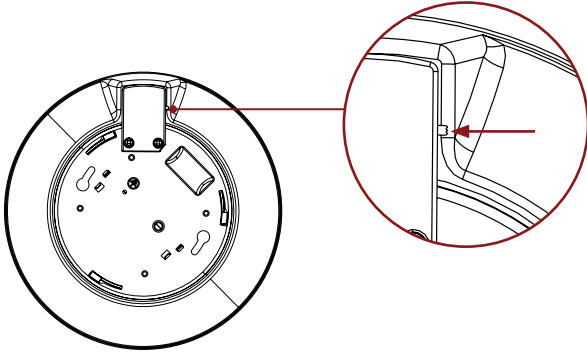

- 2** Connect the same colored power supply lead wires to the luminaire's wires using wire nuts (included)

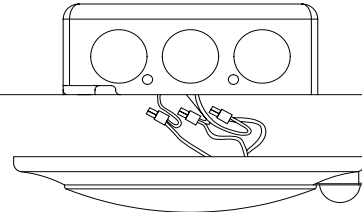

Neutral		White
Live		Black
Green		Ground

- 3** Remove the lens by turning counterclockwise to unlock.

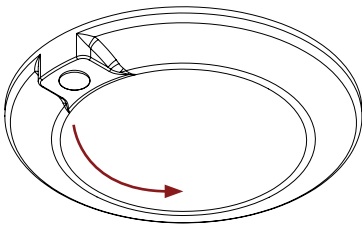

- 4** Select the desired color temperature by using the switch located under the lens. **NOTE:** Luminaire is preset at 3000K and may change in shipping / handling / installation.

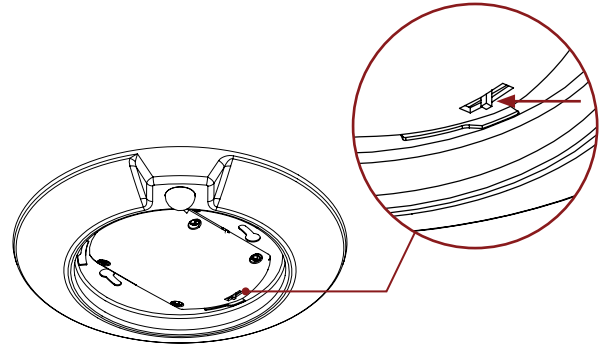

- 5** Safely place all the wires into the junction box and remove the appropriate label to prepare for installation. Mount the luminaire to the junction box (order bracket, NLOPAC-4BKT-2, if needed for installation on to 4" square junction box) and screw through the keyhole slots.

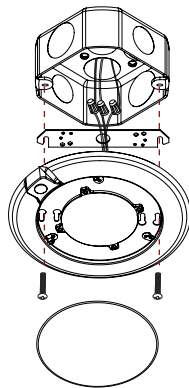

**⚠ IMPORTANT:** Should mounting holes not line up with hole(s) in junction box, secure the Opal to the ceiling material using compatible screws making sure to completely cover junction box.

- 6** Replace the lens and twist clockwise to lock.

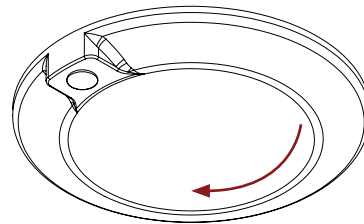

# Installation Instructions

## NLOPAC-R7MSTW

### 7" AC Opal LED Surface Mount with Selectable CCT & Motion Sensor

READ PRIOR TO ATTEMPTING INSTALLATION  
ALWAYS TURN OFF MAIN POWER BEFORE INSTALLATION  
INSTALLATION SHOULD BE CARRIED OUT BY YOUR LOCAL ELECTRICIAN

#### RETROFIT OVER HOUSING AS LED LAMP REPLACEMENT

#### REQUIRES: NLOPAC-R6TWRECKIT (ORDERED SEPARATELY)

- 1** Remove existing trim and light bulb from the recessed housing to reveal the medium base socket. If applicable, remove socket from plate.

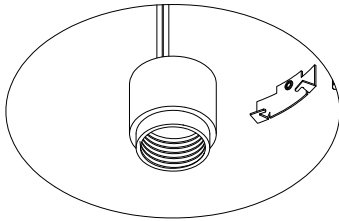

- 2** Examine all parts that are not intended to be replaced by the retrofit kit for damage and replace any damage parts prior to the installation of the luminaire. Remove luminaire's lens by turning counter clockwise to unlock.

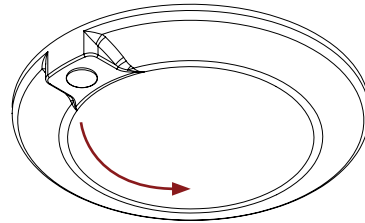

- 3** Attach torsion springs to luminaire with screws and replace lens.

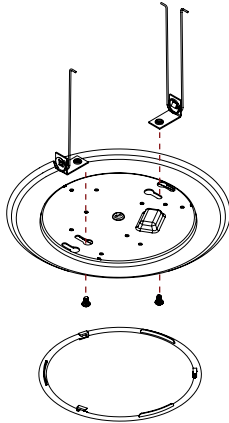

- 4** Connect luminaire's wires to medium base socket adapter with wire nuts.

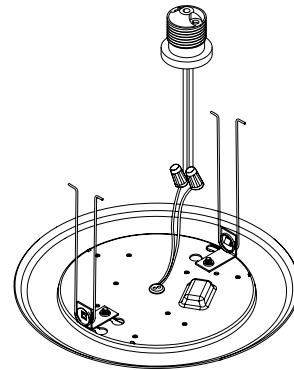

- 5** Screw in medium base socket adapter into medium base socket. Squeeze both torsion springs together and insert the torsion springs to the housing's brackets.

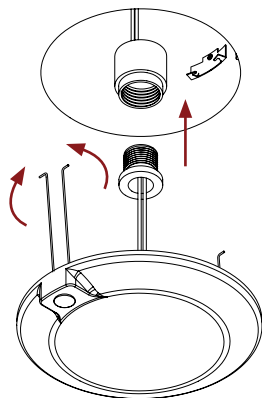

- 6** Safely place all wires into the housing and carefully push the luminaire into the housing.

