

Installation Instructions

NLCBC-569/LE4

5" Cobalt LED Adjustable Retrofit, 120-277V

READ PRIOR TO ATTEMPTING INSTALLATION
ALWAYS TURN OFF MAIN POWER BEFORE INSTALLATION
INSTALLATION SHOULD BE CARRIED OUT BY YOUR LOCAL ELECTRICIAN

⚠ WARNING: Risk of fire or electric shock. Installation of this retrofit assembly requires a person familiar with the construction and operation of the luminaire's electrical system and the hazard involved. If not qualified, do not attempt installation. Contact a qualified electrician.

⚠ AVERTISSEMENT: Risque d'incendie ou de choc électrique. L'installation de cet ensemble de rénovation nécessite une personne familiarisée avec la construction et le fonctionnement du système électrique du luminaire et les risques encourus. S'il n'est pas qualifié, n'essayez pas d'installer. Contacter un électricien qualifié.

⚠ WARNING: Risk of fire or electric shock. Install this kit only in the luminaires that has the construction features and dimensions shown in the photographs and/or drawings.

⚠ AVERTISSEMENT: Risque d'incendie ou de choc électrique. Installez ce kit uniquement dans les luminaires qui ont les caractéristiques de construction et les dimensions indiquées sur les photographies et / ou les dessins.

⚠ WARNING: To prevent wiring damage or abrasion, do not pinch or damage exposed wiring during installation. Keep away from edges of sheet metal or other sharp objects

⚠ AVERTISSEMENT: Pour éviter d'endommager ou d'abrasion le câblage, ne pas pincer ou endommager le câblage pendant l'installation. Tenir à l'écart des bords de la tôle ou d'autres objets tranchants

⚠ WARNING: Risk of fire or electric shock. Do not alter, relocate, or remove wiring, lampholders, power supply, or any other electrical component.

⚠ AVERTISSEMENT: Risque d'incendie ou de choc électrique. Ne modifiez pas, ne déplacez pas ou n'enlevez pas le câblage, les douilles de lampe, l'alimentation électrique ou tout autre composant électrique.

DO NOT MAKE OR ALTER ANY OPEN HOLES IN AN ENCLOSURE OF WIRING OR ELECTRICAL COMPONENTS DURING KIT INSTALLATION.

THIS RETROFIT KIT IS ACCEPTED AS A COMPONENT OF A LUMINAIRE WHERE THE SUITABILITY OF THE COMBINATION SHALL BE DETERMINED BY AUTHORITIES HAVING JURISDICTION.



PACKAGING CONTENTS

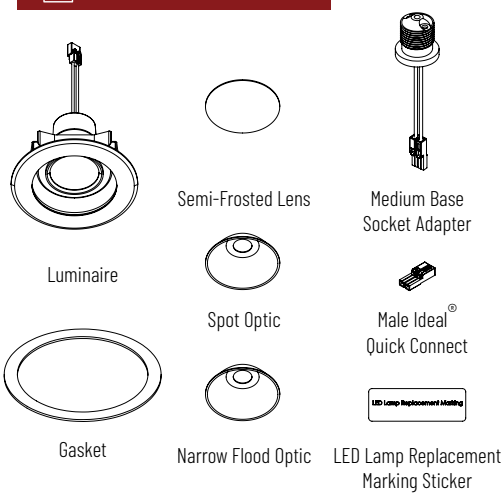

HOUSING DIMENSIONS

Housing Dimensions	
Width	5.3"
Height	6.06"

Install this kit only in luminaires that have the construction features and dimensions described in these instructions, and where the input rating of the retrofit kit does not exceed the input rating of the luminaire.

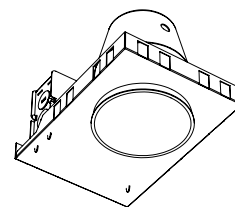

New Construction

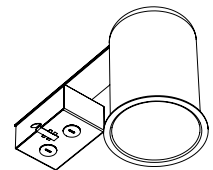

Remodel

Refer to correlation label of luminaire and/or specification sheet at www.NoraLighting.com

INSTALLING DESIRED OPTIC

Note: Flood optic is pre-installed

1. Disconnect luminaire from housing. (Figure 1)
2. Hold luminaire's reflector to prevent it from rotating. (Figure 2)
3. Turn inner ring counter-clockwise to loosen. (Figure 3)
4. Replace pre-installed flood optic and lens. **Note:** Spot and narrow flood require semi-frosted lens (included). (Figure 4)
5. Replace inner ring and turn clockwise to tighten.

Figure 1

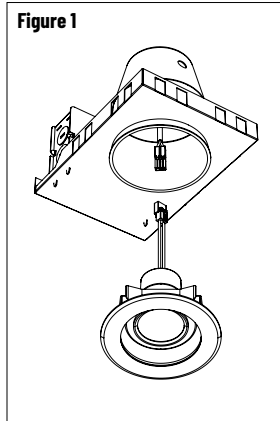

Figure 2

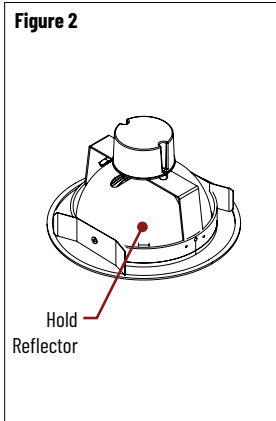

Figure 3

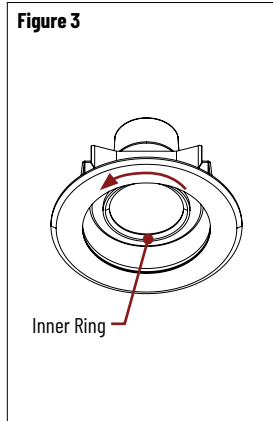
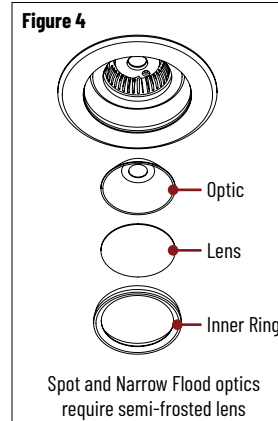

Figure 4



Installation Instructions

NLCBC-569/LE4

5" Cobalt LED Adjustable Retrofit, 120-277V

READ PRIOR TO ATTEMPTING INSTALLATION
ALWAYS TURN OFF MAIN POWER BEFORE INSTALLATION
INSTALLATION SHOULD BE CARRIED OUT BY YOUR LOCAL ELECTRICIAN

RETROFITTING INTO HOUSING WITH 120V

⚠️ TURN OFF MAIN POWER BEFORE INSTALLATION

1. Place provided LED Lamp Replacement Marking Sticker inside the housing where visible to installer.
2. Screw medium base socket adapter into medium base socket.
3. Connect Pearl LED luminaire to medium base socket adapter and carefully push fixture into the housing

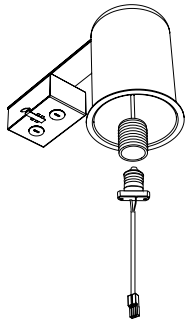

Screw medium base socket adapter

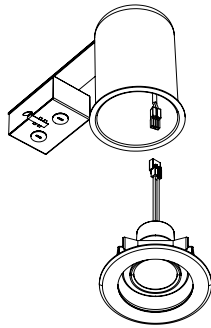

Connect luminaire and install

INSTALLATION INTO LED HOUSINGS WITH 120V

⚠️ TURN OFF MAIN POWER BEFORE INSTALLATION

1. Connect luminaire's connector to quick connect of Nora's LED dedicated housing.
2. Squeeze friction blades on reflector and carefully push fixture into the housing.
3. Carefully route wires into fixture and push fixture up flush to ceiling surface.

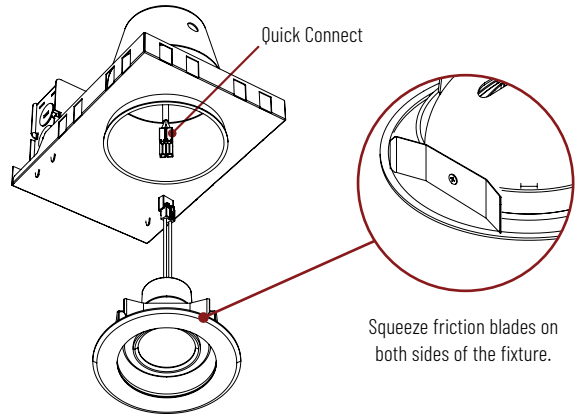

Squeeze friction blades on both sides of the fixture.

INSTALLATION INTO HOUSING WITH 277V

⚠️ TURN OFF MAIN POWER BEFORE INSTALLATION

1. Remove existing trim and light bulb from the recessed housing to reveal the medium base socket. If applicable, remove socket from plate.
2. Place provided LED Lamp Replacement Marking Sticker inside the housing where visible to installer.
3. Cut medium base socket adapter into medium base socket.
4. Connect luminaire to housing and carefully push fixture into the housing.

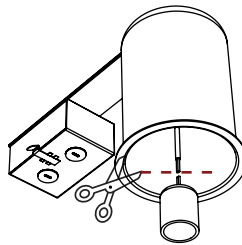

Cut medium base socket

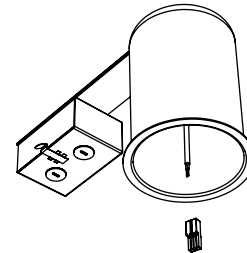

Install male quick connect

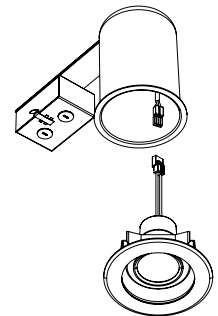

Connect luminaire and install

EMERGENCY CONNECTION (NLCBC-569xxLE4EM)

REQUIRES: NHIC-5LMRAT/6WEM, NHIC-527LMRAT/6WEM, NHRIC-5LMRAT/6WPEM or NHRIC-527LMRAT/6WPEM (Ordered Separately)

OPTIONAL LE4
0-10V DIMMING

