

Installation Instructions

NLOS-S42L

4" SURF Square LED Regressed Edge-Lit Surface Mount

READ PRIOR TO ATTEMPTING INSTALLATION
ALWAYS TURN OFF MAIN POWER BEFORE INSTALLATION
INSTALLATION SHOULD BE CARRIED OUT BY YOUR LOCAL ELECTRICIAN

⚠ IMPORTANT - This equipment is intended to be installed only by qualified personnel. The installation must be made in accordance with the current edition of the National Electrical Code and all applicable state and local building codes. The final installation must be approved by the appropriate, qualified electrical/building inspector(s). Improper installation may result in a fire or electrical hazard. Be sure the electrical power to the circuit has been disconnected before installing this electrical system.

⚠ IMPORTANT - Cet équipement est destiné à être installé uniquement par du personnel qualifié. L'installation doit être faite conformément à l'édition actuelle du Code national de l'électricité et à tous les codes de construction locaux et nationaux applicables. L'installation finale doit être approuvée par un ou plusieurs inspecteurs qualifiés en électricité / bâtiment. Une installation incorrecte peut entraîner un incendie ou un risque électrique. Assurez-vous que l'alimentation électrique du circuit a été déconnectée avant d'installer ce système électrique.



PACKAGING CONTENTS

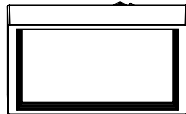

(1) 4" SURF LED Luminaire



(3) Wire Nuts, Twist-Lock

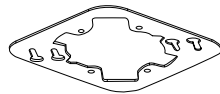

(1) Junction Box Plate



(2) Mounting Screws

COMPATIBLE JUNCTION BOX

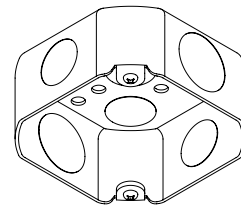

4" Octagonal Junction Box

INSTALLATION INSTRUCTIONS

1. Identify a compatible junction box. Junction box is required to have a minimum of 1.5" in height.
2. Align the mounting plate to the junction box and fasten the screws on the appropriate hole. (Refer to Figure 2 for appropriate holes) **Note:** Tighten the screws until the mounting plate is firmly against the ceiling, but do not overtighten the screws. Overtightening could distort the mounting plate, causing an uneven installation.
3. Pull the supply wires through the mounting plate.
4. While supporting the luminaire, connect the luminaire wires to the supply wires Live/Neutral/Ground. (Figure 3)
5. Carefully push connections into the junction box.
6. Align the two springs on the luminaire to the mounting plate, insert the luminaire into the mounting plate. Snap to secure.
7. Installation complete

⚠ CAUTION: Make certain that no wires are pinched between junction box mounting plate and luminaire body. To remove luminaire body from the ceiling, pull straight down.

DRIVER REPLACEMENT: Inseparable luminaire. Do not attempt to service. Replace entire fixture.

Figure 1

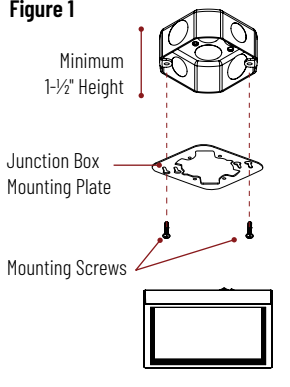

Figure 2

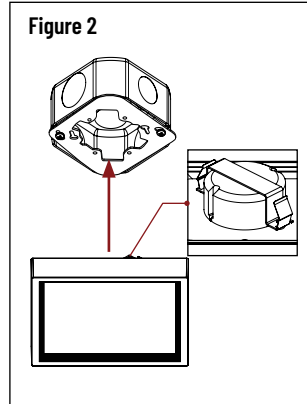

Figure 3

