

# NEXUS

## LED Driver + Dimmer All-In-One

NEXUS simplifies LED linear lighting systems by combining an in-wall LED dimmer switch and power supply into a single integrated unit. NEXUS mounts in a standard in-wall switch box, accepts 120V AC and converts to low voltage 12V or 24V DC. NEXUS is compatible with Nora LED Tape Light and LED Lightbar.

### FEATURES

- First LED Driver + In-Wall Dimmer Switch in one unit
- Simplifies LED installation by eliminating compatibility issues between driver and dimmer
- Fits in standard recessed electrical switch box
- 100% - 5% smooth dimming
- No minimum load
- Single pole preset dimmer with on/off push switch
- Adjustable voltage output dial to address voltage drop
- Includes voltage barrier partition to install high and low voltage circuit in same switch box
- No derating required when ganging units
- Power failure memory: If power is interrupted, NEXUS will return to setting prior to interruption
- Includes 3 face plates: Glossy White, Glossy Light Almond, and Glossy Dark Brown (Decora trim plate not included)
- cULus Listed



Glossy Dark Brown, Glossy White & Glossy Light Almond face plates ordered separately.



### NORA COMPATIBLE LED PRODUCTS

- LED Standard Wet and Damp Tape
- LED Hy-Brite Tape
- LED Lightbar
- LED Standard Side-Lit Tape
- LED High Output Tape
- LED Flex Light

#### NEXUS DRIVER + DIMMER ALL-IN-ONE SWITCH

SERIES	WATTAGE / VOLTAGE
<b>NATL-SWEX</b> Driver + Dimmer	<b>60/12A</b> 60W / 12V <b>60/24A</b> 60W / 24V <b>100/24A</b> 100W / 24V
<b>NATL-SWEX/3FP</b> Face Plate Kit, includes Glossy Light Almond, Glossy Black and Glossy Brown	

Example: **NATL-SWEX100/24** - 100W 24V Nexus Driver + Dimmer All-In-One Switch

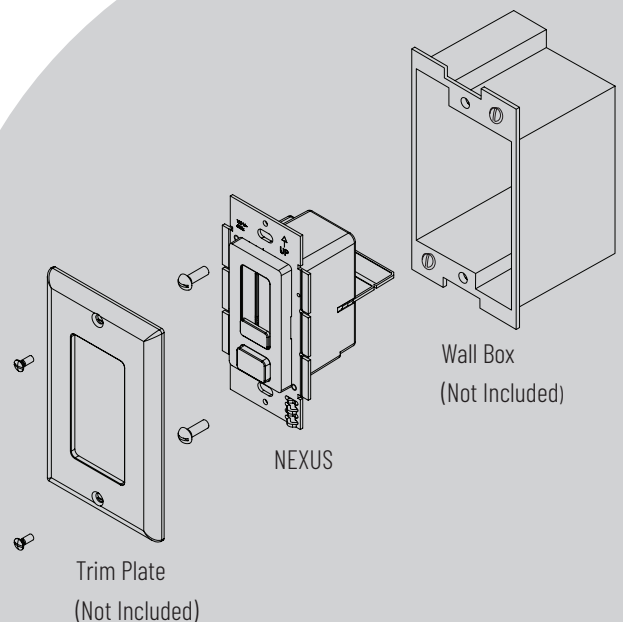

**1. TURN POWER OFF AT CIRCUIT BREAKER**

**SHOCK HAZARD!** May result in serious injury or death.  
Turn power OFF at circuit breaker prior to installation.

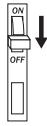

**2. DETERMINE LOCATION TO INSTALL COMPONENTS**

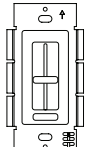

**NEXUS**

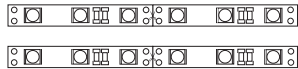

**Low Voltage Tape Light / Fixture**

**IMPORTANT:** Verify the voltage of the Nora product matches the Nora NEXUS output. NEXUS LED driver is a 12V or 24V DC unit.

**3. REMOVE EXISTING SWITCH (IF NECESSARY)**

- Remove trim plate and switch mounting screws.
- Pull switch from wall.
- Identify wires connected to switch and mark wires if desired.
- Disconnect wires from switch.

**4. CHOOSE FACE PLATE FINISH (IF NECESSARY)**

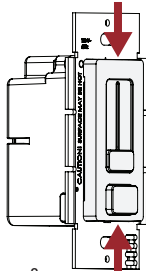

a. Gently squeeze top and bottom of face plate

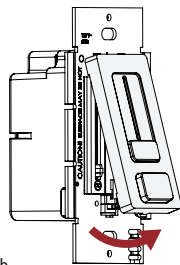

b. Lift face plate from housing

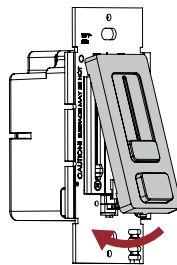

c. Insert replacement face plate into top housing groove. Position housing slider and face plate slider at minimum brightness (bottom level) and pop on face plate

**5. REMOVING FINS (IF NECESSARY)**

It's required to break off dimmer fins when ganging multiple dimmers in same wall box

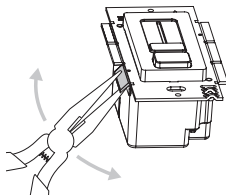

Grip with pliers. Bend back and forth until fin breaks off

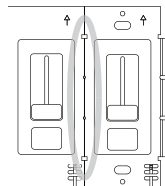

Fins have been removed

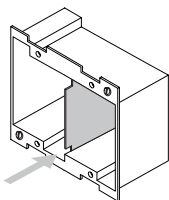

Removeable partition

**ZERO LOAD DERATING**

Unlike standard high voltage AC controls, removing SWITCHEX® fins does not reduce the dimmer's maximum wattage rating.

**6. ATTACH VOLTAGE PARTITION (BARRIER)**

A voltage barrier is provided, which separates high voltage and low voltage wires in the wall box. Attach before mounting.

**NEC CODE 725.136**

Class 1 and Class 2 circuits in same enclosure must be separated by a barrier unless Class 2 circuit conductors are installed in accordance with 725.41 Class 1 Circuits. For example, Non-Metallic (NM) cable is considered a Class 1 circuit conductor. Therefore, if both high voltage and low voltage circuits are installed with NM cable then the voltage barrier is not required for installation.

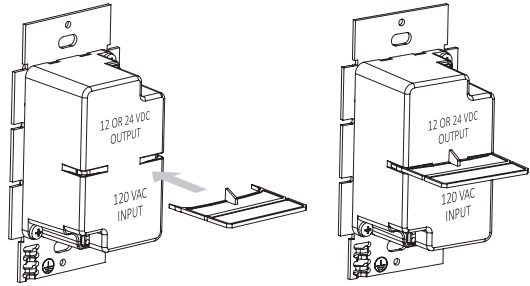

**SYSTEM DIAGRAM:**

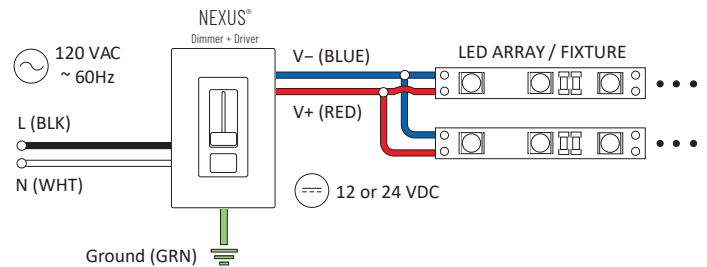

**12V VOLTAGE DROP & WIRE LENGTH DISTANCE CHART**

Wire Gauge	10 W .83 A	20 W 1.7 A	30 W 2.5 A	40 W 3.3 A	50 W 2.1 A	60 W 4.2 A
18 AWG	34 ft.	17 ft.	11 ft.	8 ft.	6 ft.	5 ft.
16 AWG	54 ft.	27 ft.	18 ft.	13 ft.	10 ft.	9 ft.
14 AWG	86 ft.	43 ft.	29 ft.	21 ft.	17 ft.	14 ft.
12 AWG	134 ft.	68 ft.	45 ft.	34 ft.	27 ft.	22 ft.
10 AWG	199 ft.	99 ft.	66 ft.	49 ft.	39 ft.	33 ft.

**24V VOLTAGE DROP & WIRE LENGTH DISTANCE CHART**

Wire Gauge	10 W .42 A	20 W .83 A	30 W 1.3 A	40 W 1.7 A	50 W 2.1 A	60 W 2.5 A	70 W 2.9 A	80 W 3.3 A	100 W 4.2 A
18 AWG	134 ft.	68 ft.	45 ft.	33 ft.	27 ft.	22 ft.	19 ft.	17 ft.	14 ft.
16 AWG	215 ft.	109 ft.	72 ft.	54 ft.	43 ft.	36 ft.	31 ft.	27 ft.	22 ft.
14 AWG	345 ft.	174 ft.	115 ft.	86 ft.	69 ft.	57 ft.	49 ft.	43 ft.	36 ft.
12 AWG	539 ft.	272 ft.	181 ft.	135 ft.	108 ft.	90 ft.	77 ft.	68 ft.	56 ft.
10 AWG	784 ft.	397 ft.	263 ft.	197 ft.	158 ft.	131 ft.	112 ft.	98 ft.	82 ft.