

Installation Instructions

NOXTW-56

5"/6" Onyx TW LED Retrofit

READ PRIOR TO ATTEMPTING INSTALLATION
ALWAYS TURN OFF MAIN POWER BEFORE INSTALLATION
INSTALLATION SHOULD BE CARRIED OUT BY YOUR LOCAL ELECTRICIAN

- ⚠ **WARNING:** Risk of fire or electric shock. Installation of this retrofit assembly requires a person familiar with the construction and operation of the luminaire's electrical system and the hazard involved. If not qualified, do not attempt installation. Contact a qualified electrician.
- ⚠ **AVERTISSEMENT:** Risque d'incendie ou de choc électrique. L'installation de cet ensemble de rénovation nécessite une personne familiarisée avec la construction et le fonctionnement du système électrique du luminaire et les risques encourus. S'il n'est pas qualifié, n'essayez pas d'installer. Contacter un électricien qualifié.
- ⚠ **WARNING:** Risk of fire or electric shock. Install this kit only in the luminaires that has the construction features and dimensions shown in the photographs and/or drawings.
- ⚠ **AVERTISSEMENT:** Risque d'incendie ou de choc électrique. Installez ce kit uniquement dans les luminaires qui ont les caractéristiques de construction et les dimensions indiquées sur les photographies et / ou les dessins.
- ⚠ **WARNING:** To prevent wiring damage or abrasion, do not pinch or damage expose wiring during installation. Keep away from to edges of sheet metal or other sharp objects
- ⚠ **AVERTISSEMENT:** Pour éviter d'endommager ou d'abrasion le câblage, ne pas pincer ou endommager le câblage pendant l'installation. Tenir à l'écart des bords de la tôle ou d'autres objets tranchants
- ⚠ **WARNING:** Risk of fire or electric shock. Do not alter, relocate, or remove wiring, lampholders, power supply, or any other electrical component.
- ⚠ **AVERTISSEMENT:** Risque d'incendie ou de choc électrique. Ne modifiez pas, ne déplacez pas ou n'enlevez pas le câblage, les douilles de lampe, l'alimentation électrique ou tout autre composant électrique.

DO NOT MAKE OR ALTER ANY OPEN HOLES IN AN ENCLOSURE OF WIRING OR ELECTRICAL COMPONENTS DURING KIT INSTALLATION.

THIS RETROFIT KIT IS ACCEPTED AS A COMPONENT OF A LUMINAIRE WHERE THE SUITABILITY OF THE COMBINATION SHALL BE DETERMINED BY AUTHORITIES HAVING JURISDICTION.



PACKAGING CONTENTS

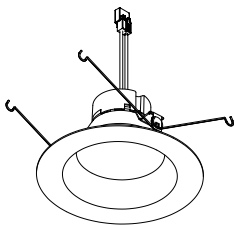

Retrofit

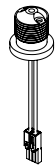

Medium Base
Socket Adapter



Gasket



LED Lamp Replacement
Marking Sticker



HOUSING DIMENSIONS

Min. Diameter	Min. Height	Max. number of 12AWG through branch wiring
6" (153mm)	5.5" (139mm)	8
5.3" (134mm)	5.6" (153mm)	8

Install this kit only in luminaires that have the construction features and dimensions described in these instructions, and where the input rating of the retrofit kit does not exceed the input rating of the luminaire.

Refer to correlation label of luminaire and/or specification sheet at www.NoraLighting.com

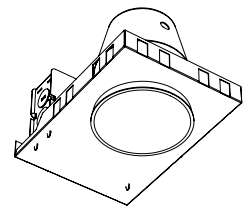

New Construction

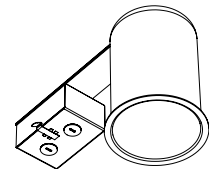

Remodel

INSERT ACCESSORY INSTALLATION (NOXTW-5631 ONLY)

REQUIRES: NOX-56REFL or NOX-56BAF (Ordered Separately)

NOTE: NOXTW-5631 only accepts accessories

Installation: Push the insert accessory into the lens until it snaps-in.

Removal: Not recommended to remove insert accessory after installation as lens may detach from the trim. Firmly hold the lens down while removing insert accessory. If lens detaches, push the lens back until it clicks.

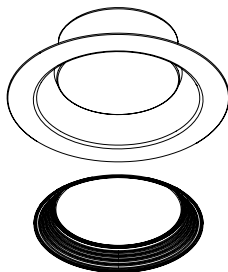

SELECTING COLOR TEMPERATURE

NOTE: Retrofit is preset to 3000K and may have been changed in shipping / handling. Select color temperature prior to installation.

- Color temperature can be changed with five position switch located on top of the driver.

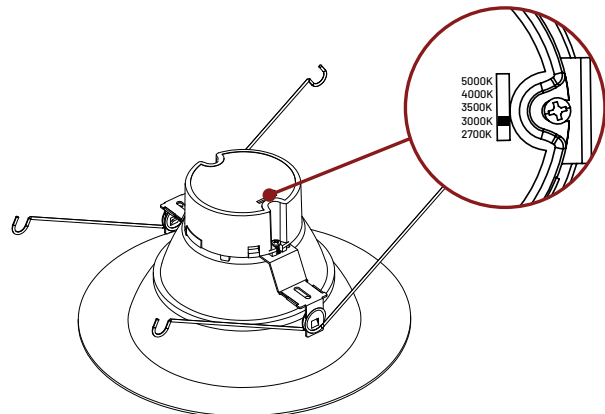

Installation Instructions

NOXTW-56

5"/6" Onyx TW LED Retrofit

READ PRIOR TO ATTEMPTING INSTALLATION
ALWAYS TURN OFF MAIN POWER BEFORE INSTALLATION
INSTALLATION SHOULD BE CARRIED OUT BY YOUR LOCAL ELECTRICIAN

RETROFITTING INTO HOUSING

⚠️ TURN OFF MAIN POWER BEFORE INSTALLATION

1. Remove existing trim and light bulb from the recessed housing to reveal the medium base socket. If applicable, remove socket from plate.
2. Place provided LED Lamp Replacement Marking Sticker inside the housing where visible to installer.
3. Screw medium base socket adapter into medium base socket. (Figure 1)
4. Connect fixture's connector to male orange connector and squeeze torsion springs together to insert into the housing. (Figure 2)
5. Carefully place wires into the housing and push fixture up flush to ceiling surface.

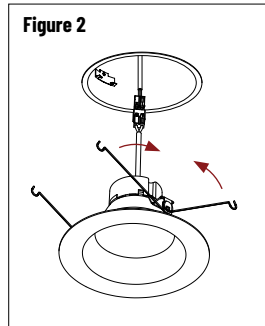
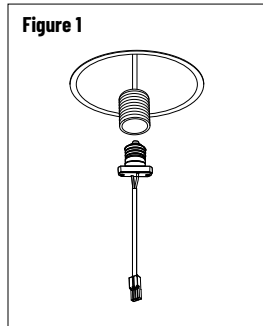

INSTALLATION INTO LED HOUSING

⚠️ TURN OFF MAIN POWER BEFORE INSTALLATION

1. Connect fixture's connector to quick connect of Nora's LED dedicated housing. (Figure 1)
2. Squeeze torsion springs together to insert into the housing. (Figure 2)
3. Carefully place wires into the housing and push fixture up flush to ceiling surface.

