

# Installation Instructions

NPR-4RPH

4" Pearl 120V LED Pinhole Retrofit

**READ PRIOR TO ATTEMPTING INSTALLATION**  
**ALWAYS TURN OFF MAIN POWER BEFORE INSTALLATION**  
**INSTALLATION SHOULD BE CARRIED OUT BY YOUR LOCAL ELECTRICIAN**

- ⚠ WARNING:** Risk of fire or electric shock. Installation of this retrofit assembly requires a person familiar with the construction and operation of the luminaire's electrical system and the hazard involved. If not qualified, do not attempt installation. Contact a qualified electrician.
- ⚠ AVERTISSEMENT:** Risque d'incendie ou de choc électrique. L'installation de cet ensemble de rénovation nécessite une personne familiarisée avec la construction et le fonctionnement du système électrique du luminaire et les risques encourus. S'il n'est pas qualifié, n'essayez pas d'installer. Contacter un électricien qualifié.
- ⚠ WARNING:** Risk of fire or electric shock. Install this kit only in the luminaires that has the construction features and dimensions shown in the photographs and/or drawings.
- ⚠ AVERTISSEMENT:** Risque d'incendie ou de choc électrique. Installez ce kit uniquement dans les luminaires qui ont les caractéristiques de construction et les dimensions indiquées sur les photographies et / ou les dessins.
- ⚠ WARNING:** To prevent wiring damage or abrasion, do not pinch or damage expose wiring during installation. Keep away from to edges of sheet metal or other sharp objects
- ⚠ AVERTISSEMENT:** Pour éviter d'endommager ou d'abrasion le câblage, ne pas pincer ou endommager le câblage pendant l'installation. Tenir à l'écart des bords de la tôle ou d'autres objets tranchants
- ⚠ WARNING:** Risk of fire or electric shock. Do not alter, relocate, or remove wiring, lampholders, power supply, or any other electrical component.
- ⚠ AVERTISSEMENT:** Risque d'incendie ou de choc électrique. Ne modifiez pas, ne déplacez pas ou n'enlevez pas le câblage, les douilles de lampe, l'alimentation électrique ou tout autre composant électrique.

**DO NOT MAKE OR ALTER ANY OPEN HOLES IN AN ENCLOSURE OF WIRING OR ELECTRICAL COMPONENTS DURING KIT INSTALLATION.**

**THIS RETROFIT KIT IS ACCEPTED AS A COMPONENT OF A LUMINAIRE WHERE THE SUITABILITY OF THE COMBINATION SHALL BE DETERMINED BY AUTHORITIES HAVING JURISDICTION.**



## PACKAGING CONTENTS

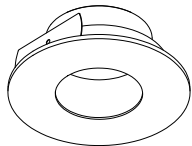

Trim



Male Ideal<sup>®</sup>  
Quick Connect



LED Lamp Replacement  
Marking Sticker

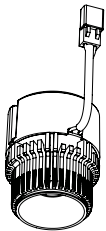

Pearl LED module/retrofit kit  
Flood optic (NIO-REFL60) installed

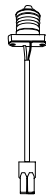

Medium Base  
Socket Adapter



Narrow Flood Optic  
(NIO-REFL38)



Spot Optic  
(NIO-REFL25)



## HOUSING DIMENSIONS

Refer to correlation label of luminaire and/or specification sheet at [www.NoraLighting.com](http://www.NoraLighting.com)

Install this kit only in luminaires that have the construction features and dimensions described in these instructions, and where the input rating of the retrofit kit does not exceed the input rating of the luminaire.

**Max. Number of 12AWG through branch wiring: 8**

| Housing Dimensions |       |
|--------------------|-------|
| Width              | 4.03" |
| Height             | 3.54" |

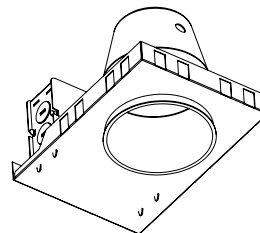

New Construction

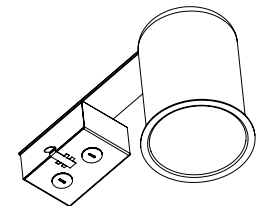

Remodel

## INSTALLING DESIRED OPTIC

**Note:** Flood optic is pre-installed

1. Remove retrofit luminaire from its packaging.
2. Install desired optic (Note: flood optic is pre-installed). Pull pre-installed flood optic from heat sink. Align desired optic to module. Push the optic into place.
3. Attach LED module/driver and optic onto trim by threading heatsink clockwise.



Replace optic,  
if desired

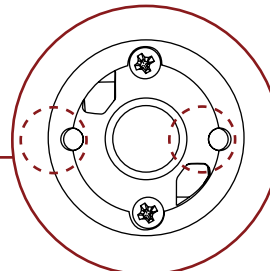

Align optic feet to module

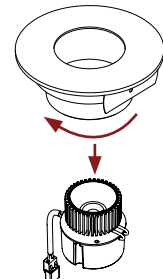

Attach LED module/driver  
and thread clockwise

# Installation Instructions

NPR-4RPH

4" Pearl 120V LED Pinhole Retrofit

READ PRIOR TO ATTEMPTING INSTALLATION  
ALWAYS TURN OFF MAIN POWER BEFORE INSTALLATION  
INSTALLATION SHOULD BE CARRIED OUT BY YOUR LOCAL ELECTRICIAN

## INSTALLATION INTO LED HOUSINGS

### ⚠️ TURN OFF MAIN POWER BEFORE INSTALLATION

1. Connect luminaire's connector to quick connect of Nora's LED dedicated housing.
2. Squeeze friction blades towards unit and install into recessed housing.
3. Carefully route wires into fixture and push fixture up flush to ceiling surface.

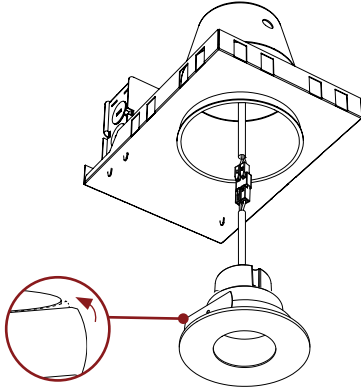

## RETROFITTING INTO HOUSING AS LED CONVERSION

### ⚠️ TURN OFF MAIN POWER BEFORE INSTALLATION

1. Remove existing trim and light bulb from the recessed housing to reveal the medium base socket. If applicable, remove socket from plate.
2. Place provided LED Lamp Replacement Marking Sticker inside the housing where visible to installer.
3. Cut medium base socket cable off existing housing and connect wires maintaining polarity using the provided male orange connector.
4. Connect luminaire to housing and carefully push fixture into the housing

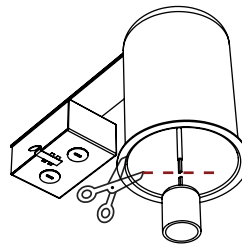

Cut medium base socket

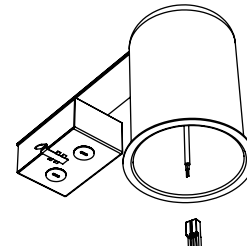

Install male quick connect

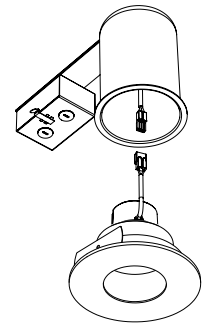

Connect luminaire and install

## RETROFITTING INTO HOUSINGS AS LED LAMP REPLACEMENT

### ⚠️ TURN OFF MAIN POWER BEFORE INSTALLATION

1. Remove existing trim and light bulb from the recessed housing to reveal the medium base socket. If applicable, remove socket from plate.
2. Place provided LED Lamp Replacement Marking Sticker inside the housing where visible to installer.
3. Screw medium base socket adapter into medium base socket. (Figure 1)
4. Carefully place wires into the housing and push fixture up flush to ceiling surface. (Figure 2)

