

Installation Instructions

NLUD-4WM

Wall Mount Kit for NLUD-4334

READ PRIOR TO ATTEMPTING INSTALLATION
ALWAYS TURN OFF MAIN POWER BEFORE INSTALLATION
INSTALLATION SHOULD BE CARRIED OUT BY YOUR LOCAL ELECTRICIAN

⚠ WARNING - This equipment is intended to be installed only by qualified personnel. The installation must be made in accordance with the current edition to the National Electric Code and all applicable state and local building codes. The final installation must be approved by the appropriate qualified electrical/building inspector(s). Improper installation may result in a fire or electrical hazard. Be sure the electrical power to the circuit has been disconnected before installing this electrical system.

⚠ AVERTISSEMENT - Cet équipement est destiné à être installé uniquement par du personnel qualifié. L'installation doit être faite en conformité avec l'édition actuelle du Code national de l'électricité et toutes étatiques et locales codes du bâtiment applicables. L'installation finale doit être approuvée par l'inspecteur en électricité / bâtiment qualifié approprié(s). Une mauvaise installation peut entraîner un incendie ou un risque électrique. Soyez sûr de la puissance électrique vers le circuit a été coupée avant l'installation de ce système électrique.

PACKAGING CONTENTS

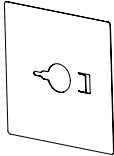

Cover Plate



Set Screw

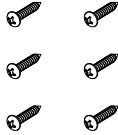

(6) Screws



(6) Drywall Anchors

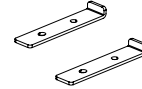

(2) L-Brackets



(4) Thumb Screws

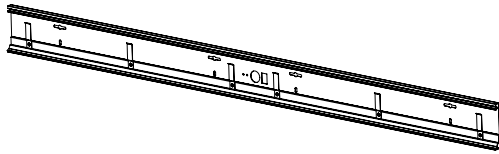

Wall Mount Plate

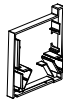

End Cap (Left Side)

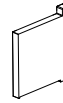

End Cap (Right Side)



Two Wire Quick Connect



Three Wire Quick Connect

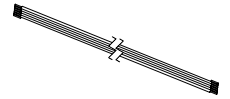

Power Cord

EXPLODED VIEW

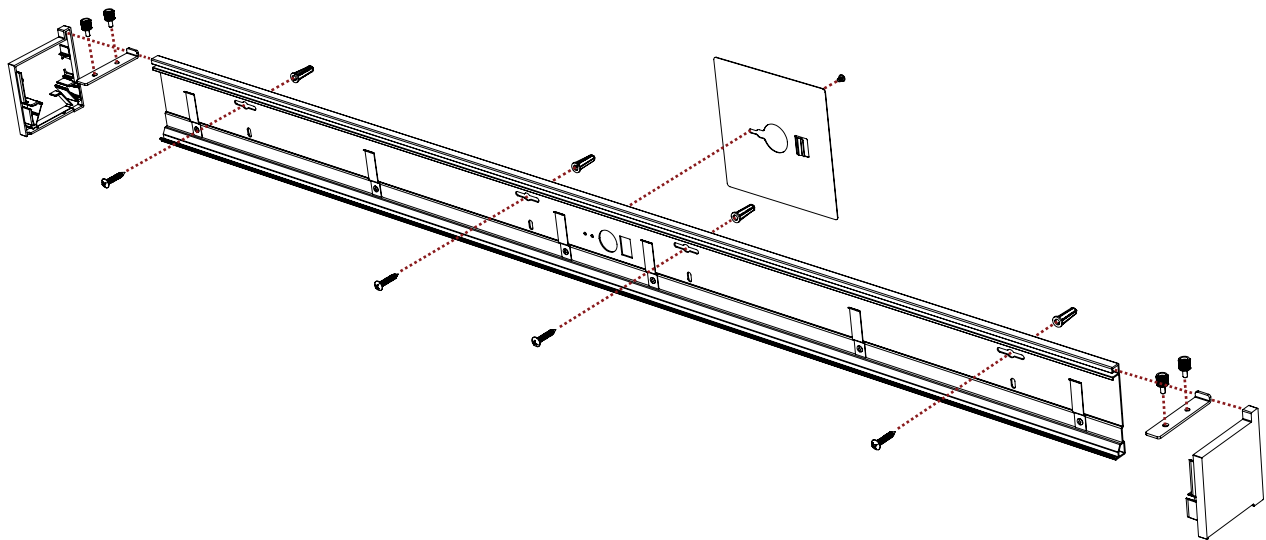

Installation Instructions

NLUD-4WM

Wall Mount Kit for NLUD-4334

READ PRIOR TO ATTEMPTING INSTALLATION
ALWAYS TURN OFF MAIN POWER BEFORE INSTALLATION
INSTALLATION SHOULD BE CARRIED OUT BY YOUR LOCAL ELECTRICIAN

INSTALLATION

⚠️ TURN OFF MAIN POWER BEFORE INSTALLATION

REQUIRES: NLUD-4334 (Ordered Separately)

1. Attach cover plate to wall mount plate by sliding cover's tab into rectangular aperture on wall mount plate. Attach set screw to the back of the cover plate. (Figure 1)
2. Route power cord through cover plate and wire accordingly with wire nuts inside junction box:
 - Black (120-347V) = Supply Voltage
 - White = Neutral
 - Green or Copper Wire = Grounding Junction Box Wire0-10V Wiring:
 - Purple = Dim (+)
 - Pink or Grey = Dim (-)
3. Mount the wall plate with cover plate over the junction box and fasten with screws and drywall anchors (if needed). (Figure 2)
4. Determine orientation of luminaire as power cord must be routed to power feed side. Route the power cord behind wire guide brackets. (Figure 3)
5. Remove both end caps on luminaire (NLUD-4334) and carefully slide through wall plate. **NOTE:** Luminaire must be wired on power feed location. (Figure 4)
6. Slide L-Brackets into each end of wall mount plate and attach brackets to luminaire with thumb screws. (Figure 5)
7. Connect power cord to 3-wire male and 2-wire male quick connects (included). (Figure 6)
8. Connect power cord to luminaire's input wires and tuck wires into the luminaire. Place wall mount end caps (included) onto both ends. (Figure 7)
9. Installation complete for single luminaire. (Figure 8) **NOTE:** For additional luminaires refer to luminaire instruction sheet.

