

NWLIN

L-Line LED Wall Mount Linear

Source: 23W to 82W LED
2100lm to 8400lm

Type

Project

Catalog No.

Notes

PRODUCT DESCRIPTION

Wall mounted L-Line Series offers a clean and modern appearance with a sleek extruded aluminum housing. Symmetrical light distribution will evenly illuminate surfaces with a diffused lens, making the L-Line ideal for commercial, retail, healthcare and education applications.

FEATURES

- 2' to 8' linear luminaires
- 1050 lumens per foot
- 3000K, 3500K, 4000K
- 0-10V dimming
- 120-277V input
- Different size wall plates for each application
- Aluminum finish

SPECIFICATION

Construction: One piece extruded aluminum housing with solid end caps. Includes diffused polycarbonate lens for symmetrical light distribution.

Mounting: Luminaires come with either a horizontal 2"x4" or universal 4"x4" wall plates to install over horizontal 2"x4" junction box, 4"x4" junction box or drywall.

Daisy Chain: Luminaires can be connected with internal quick connects. Each luminaire includes daisy chain bracket, no accessory needed. Only one power feed is required at the beginning per each run.

ELECTRICAL

Input Voltage: 120-277V

Lumens / Wattage:

NWLIN-2 = 2100lm / 23W; **NWLIN-4** = 4200lm / 41W; **NWLIN-8** = 8400lm / 82W

Color Temperature: 3000K, 3500K, 4000K

Color Rendering Index: 80+ CRI

Operating Temperature: 0°C to 30°C

Dimming: 0-10V dimming down to 10%

Maximum Run Length: 80'

LABELS AND LISTINGS

- cULus Listed for Damp Location
- 5-Year Limited Warranty



PRODUCT IMAGES & DIMENSIONS

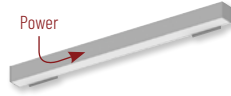
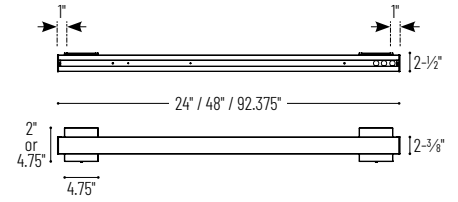

NWLIN-210A/L2P-R2
2" x 4" Left (power feed)
2" x 4" Right

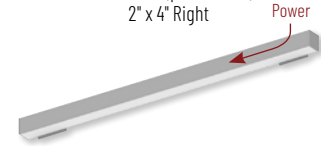

NWLIN-410A/L2-R2P
2" x 4" Left
2" x 4" Right (power feed)

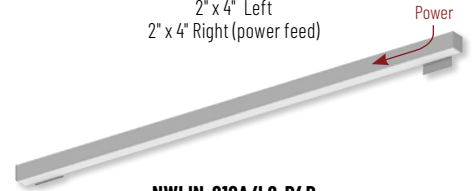

NWLIN-810A/L2-R4P
2" x 4" Left
4" x 4" Right (power feed)

L-Line LED Wall Mount Linear

Length	Lumens Per Foot	Color Temp.	Finish	Left Wall Plate	Right Wall Plate
NWLIN-2 = 2' (actual: 24")	10 = 1050lm/ft.	30 = 3000K	A = Aluminum	/L2 = 2"x4" Horizontal Plate	-R2 = 2"x4" Horizontal Plate
NWLIN-4 = 4' (actual: 48")		35 = 3500K		/L2P = 2"x4" Horizontal Plate (Power Feed)	-R2P = 2"x4" Horizontal Plate (Power Feed)
NWLIN-8 = 8' (actual: 92.375")		40 = 4000K		/L4 = 4"x4" Square Plate	-R4 = 4"x4" Square Plate
				/L4P = 4"x4" Square Plate (Power Feed)	-R4P = 4"x4" Square Plate (Power Feed)

Example: **NWLIN-81030A/L2P-R2** = 2' L-Line Wall Mount LED Linear, 2100lm / 23W, 3000K, Aluminum finish, 2"x4" Left Horizontal Plate (Power Feed) & 2"x4" Right Horizontal Plate

PHOTOMETRICS

L-Line LED Wall Mount Linear

Type _____

Project _____

Catalog No. _____

Notes _____

Test Information

Test Number: 12284668.01
 Part Number: NWLIN-21030A
 Lumens: 2637lm
 Wattage: 22W
 Efficacy: 120lpw
 CCT / CRI: 3000K / 80 CRI
 Spacing Criteria (0°-180): 1.2
 Spacing Criteria (90°-270): 1.2

Polar Curve

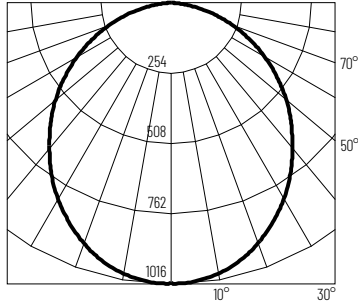

Zonal Lumen Summary

Zone	Lumens	% Luminaire
0-30	763	28.9
0-40	1227	46.5
0-60	2105	79.8
0-90	2637	100
90-180	0	0
0-180	2637	100

Candela Table

Vertical Angles	Candela
0	1010
5	997
15	949
25	860
35	742
45	607

Test Information

Test Number: 12284668.04
 Part Number: NWLIN-41030A
 Lumens: 4453lm
 Wattage: 38W
 Efficacy: 118lpw
 CCT / CRI: 3000K / 80 CRI
 Spacing Criteria (0°-180): 1.2
 Spacing Criteria (90°-270): 1.2

Polar Curve

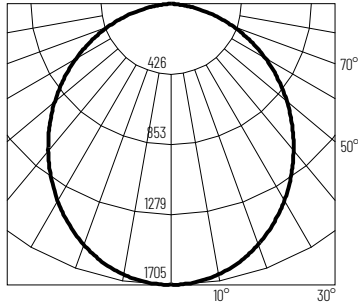

Zonal Lumen Summary

Zone	Lumens	% Luminaire
0-30	1286	28.9
0-40	2073	46.5
0-60	3562	80
0-90	4453	100
90-180	0	0
0-180	4453	100

Candela Table

Vertical Angles	Candela
0	1700
5	1681
15	1605
25	1460
35	1263
45	1033

Customer:

Project Name:

Notes:

Layout Instructions:

*** ALL ORDERS ARE CUSTOM, NON-CANCELABLE AND NON-RETURNABLE ***

1. Specify Luminaire Length
2. Specify Color Temperature
3. Specify Left Plate
4. Specify Right Plate

Quote #:

PO #:

Model Number: NWLIN- 10 A/L -R

Model Number Instructions: NWLIN-length 10 cct A/L leftplate -R rightplate

Length: 2, 4, 8

CCT: 30, 35 or 40

Left Plate: 2, 2P, 4, 4P

Right Plate: 2, 2P, 4, 4P

Luminaire Length	
Length	Description
2	2' (actual: 24in.)
4	4' (actual: 48in.)
8	8' (actual: 92.375in.)

Color Temperature	
CCT	Description
30	3000K
35	3500K
40	4000K

Left Wall Plate	
Left Plate	Description
2	2" x 4" Horizontal Plate
2P	2" x 4" Horizontal Plate (Power Feed)
4	4" x 4" Square Plate
4P	4" x 4" Square Plate (Power Feed)

Right Wall Plate	
Right Plate	Description
2	2" x 4" Horizontal Plate
2P	2" x 4" Horizontal Plate (Power Feed)
4	4" x 4" Square Plate
4P	4" x 4" Square Plate (Power Feed)

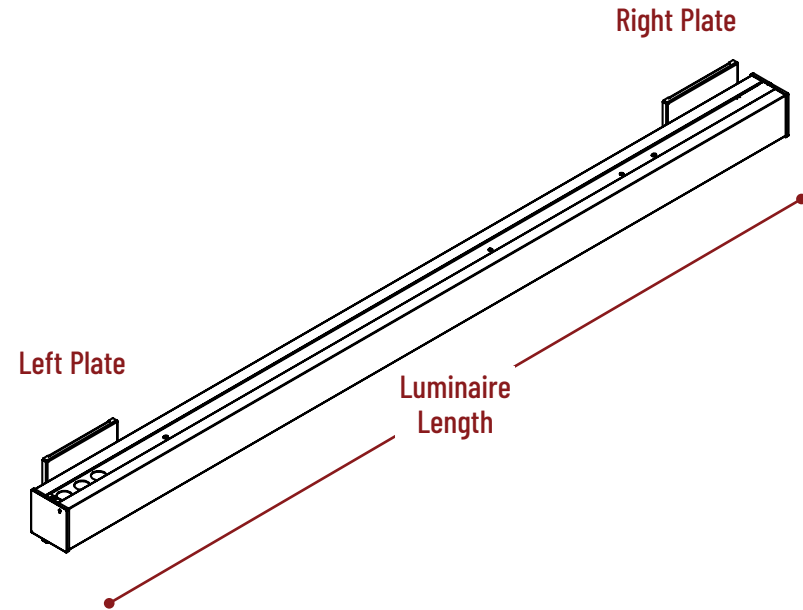

Model Number Instructions: NWLIN-length 10 cct A/L leftplate -R rightplate
 Length: 2, 4, 8
 CCT: 30, 35 or 40
 Left Plate: 2, 2P, 4, 4P
 Right Plate: 2, 2P, 4, 4P

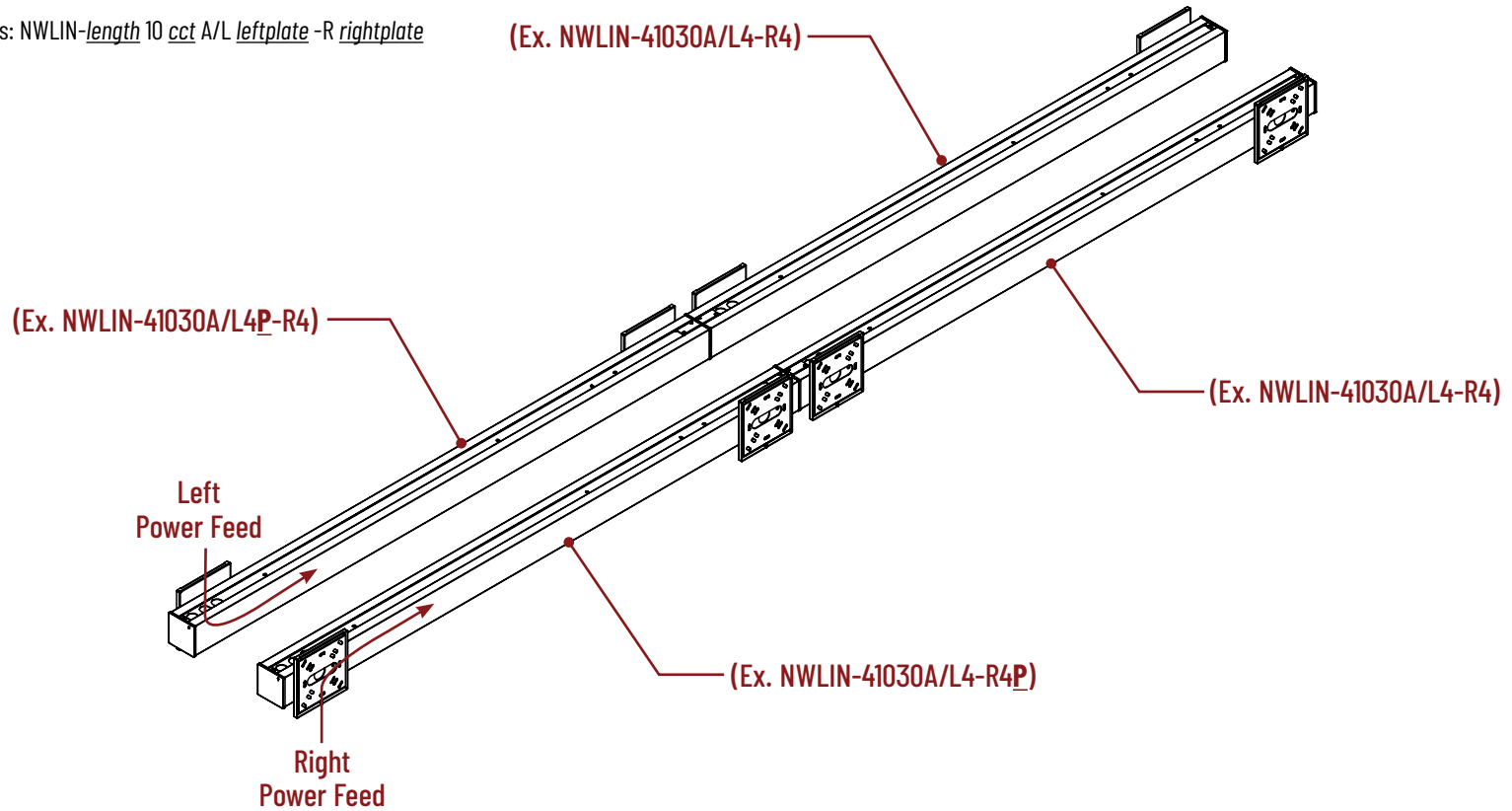

Left Power Feed	
Quantity	Model Number

Power Feed

Right Power Feed	
Quantity	Model Number

Power Feed

**All NWLIN layout sheets will be reviewed for compatibility and accuracy by our Tech team.
 Please allow additional time for order processing.**