

NMP2-A

24V Adjustable Josh LED Puck Light

Source: 3.5W LED
300lm

Type

Project

Catalog No.

Notes

PRODUCT DESCRIPTION

Adjustable Josh, a slim light disk LED system for accent, under cabinet, in-cabinet, niche, and jewelry cases, and other applications with limited space. These low-profile fixtures can be spaced together to provide excellent and even illumination on all surfaces. The Josh pucks does not produce a diode image and can be recessed or surface mounted. Combined with ultra low-profile housing, Josh offers unique features and a great ease of installation. LED technology eliminates forward heat from the fixture, also no UV or infrared rays to harm artwork, retail displays or heat sensitive foods. The luminaire produces more light than a traditional 20 watt xenon or halogen puck while consuming only 3.5 watts each puck.

FEATURES

- 18° Adjustment
- 24V Low Voltage System
- 2700K, 3000K, 3500K or 4000K @ 90+ CRI
- Recessed or surface mount
- Easy installation
- Dimmable with power supply
- 12" to 48" extension cables accessory available
- No flicker delay or warm up like compact fluorescent products
- No UV light or infrared wavelengths
- 5-Year Limited Warranty
- Each puck comes with a 72" wire and connector

ELECTRICAL

Input Voltage: 24VDC

Lumens / Wattage: 300lm / 3.5W

Color Temperature: 2700K, 3000K, 3500K, 4000K

Color Rendering Index: 90+ CRI

Operating Temperature: 0°C to 40°C

Cord Length: 72" wire and connector

Maximum # of Units Per Interconnect: Six luminaires can be connected to interconnect (NMPA-6P-24). Each luminaire must connect to interconnect, cannot daisy chain.

Life Expectancy: 50,000 hours

Dimming: Specified by driver

Cabinet Installation: Up to three puck lights may be installed in an enclosed cabinet size of 3.5" x 11.5" x 12"

LABELS AND LISTINGS

- cULus Listed for Damp Location
- cULus Listed for under-cabinet and cabinet use
- 5-Year Limited Warranty
- RoHS compliant



PRODUCT IMAGES AND DIMENSIONS

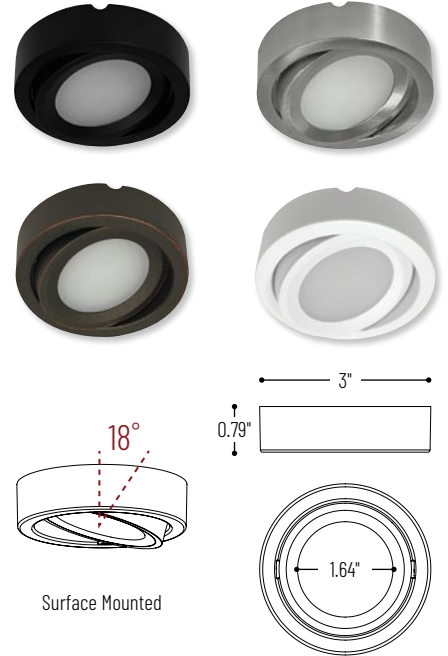

NMP2-A
Adjustable Josh LED Puck Light



NMP2-AREC
Recessed Flange Accessory

24V Adjustable Josh LED Puck Light

Color Temperature	Finish
NMP2-A27 = 2700K	B = Black
NMP2-A30 = 3000K	BZ = Bronze
NMP2-A35 = 3500K	BN = Brushed Nickel
NMP2-A40 = 4000K	W = White

Recessed Flange Accessory

Accessory Type	Finish
NMP2-AREC = Recessed Flange	B = Black
	BZ = Bronze
	BN = Brushed Nickel
	W = White

Example: **NMP2-A30W** = 24V Adjustable Josh LED Puck Light, 3000K, White Finish

NMP2-A

24V Adjustable Josh LED Puck Light Accessories

Type

Project

Catalog No.

Notes



6-Port Power Line Interconnect

NMPA-6P-24B Black
NMPA-6P-24W White

Terminal block connects up to six LED Josh Puck lights to a Nora driver. Includes 24" cord with RCA jack.



Extension Cable

NMPA-EW-12 12"
NMPA-EW-24 24"
NMPA-EW-36 36"
NMPA-EW-48 48"

Finish: Black (B), White (W)

Used to extend the length of the cable from the puck to the terminal block. Linkable up to 110'.



2' Wire Raceway

NATL-422B Black
NATL-422W White

Field-cuttable plastic. Includes wire channel with double faced tape and cover.



In-Line Touch Dimmer

NATL-518W

72W max., no power fail memory, touch on/off and hold to dim.



Direct Plug-In LED Driver

NATL-524W 24V 24W
NATL-545W 24V 45W

Input Voltage: 120V
Cable Length: 6'



Direct Plug-In LED Driver

NATL-596W 24V 96W

Input Voltage: 120V
Input Wire: 44" Cord and Plug
Output Wire: 58" Power line connector



Class II Universal Dimming Driver

NPSU-60W/24 60W
NPSU-96W/24 96W
NPSU-3X96W/24 3x 96W

Input Voltage: 110-277V
Dimming: Triac, ELV, MLV, 0-10V, PWM
Note: Power Line Connector(s) not included



Class II Hardwire LED Driver
ELV Dimming

NATLED-5040HW 24V 40W
NATLED-5075HW 24V 75W

Input Voltage: 120V
Dimming: ELV
Includes: 10' Power Line Connector



Class II Hardwire LED Driver
MLV Dimming

NMT-48/24C2D1 48W

Input Voltage: 120V
Dimming: Magnetic Low Voltage
Includes: 10' Power Line Connector



Class II Hardwire LED Driver
with Regulator, MLV Dimming

NMTD-60/24D 24V 60W
NMTD-96/24D 24V 96W

Input Voltage: 120-277V
Dimming: Magnetic Low Voltage
Regulator: Integral regulator for constant current and voltage
Includes: 10' Power Line Connector



Power Line Connector

NATL-10 10' Power Line
NATL-30 30' Power Line

For use with Class II drivers. Carries output from driver, requires power line interconnectors.

NATL-302W 5" Splitter

Splits power line connector into two separate leads, requires power line cable.



Low Voltage Splice Box

NATL-415W

Use to join low voltage lead to low voltage power line connector or interconnector.



Terminal Block

NATL-407 4-Way
2-3/8"L x 1-1/8"W x 7/8"D
NATL-408 8-Way
4"L x 1-1/8"W x 7/8"D



Wire Clip, Plastic - 10pk

NATL-404W J-Clip
NATL-405W Over the Wire
NATL-406W Square Clip

NMP2-A Sample Layout

24V Adjustable Josh LED Puck Light

Type _____
 Project _____
 Catalog No. _____
 Notes _____

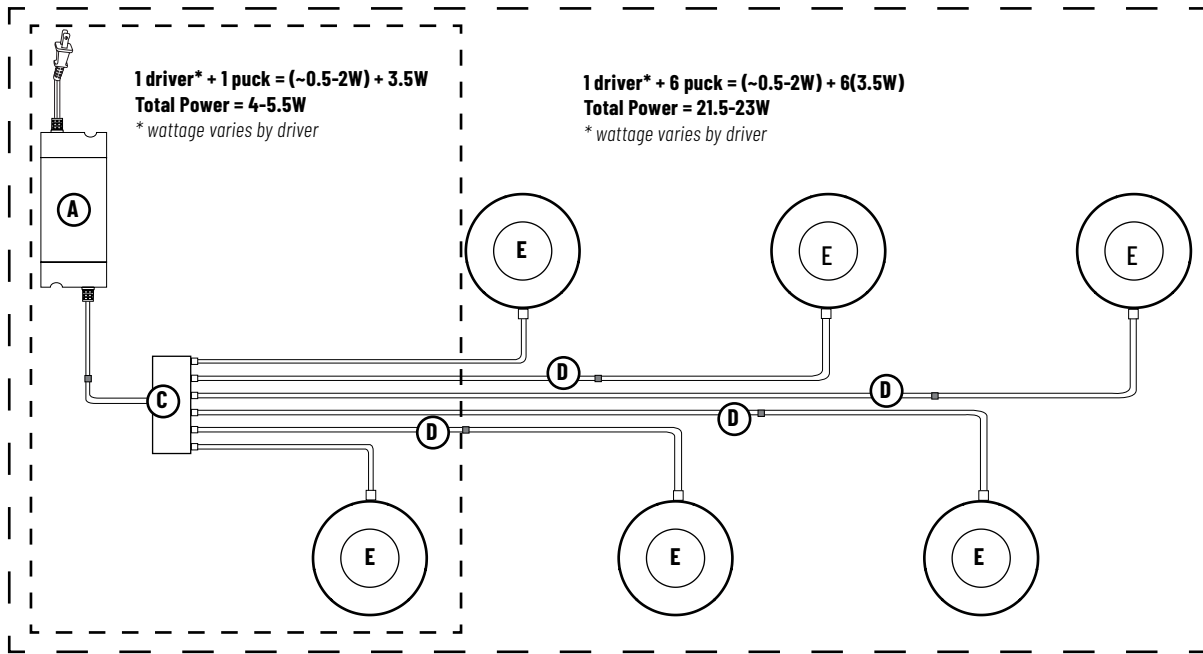

A	NATL-545W	24V 45W Direct Plug-In Driver
A2	NMTD-60/24D	24V 60W Dimmable Class II Power Supply
B	NALTL-10	10' Power Line Connector
C	NMPA-6P-24	Power Line Interconnect with 6-port terminal block
D	NMPA-EW-12B/W NMPA-EW-24B/W NMPA-EW-36B/W NMPA-EW-48B/W	12" Extension Cable 24" Extension Cable 36" Extension Cable 48" Extension Cable
E	NMP2-A	24V Adjustable Josh LED Puck Light

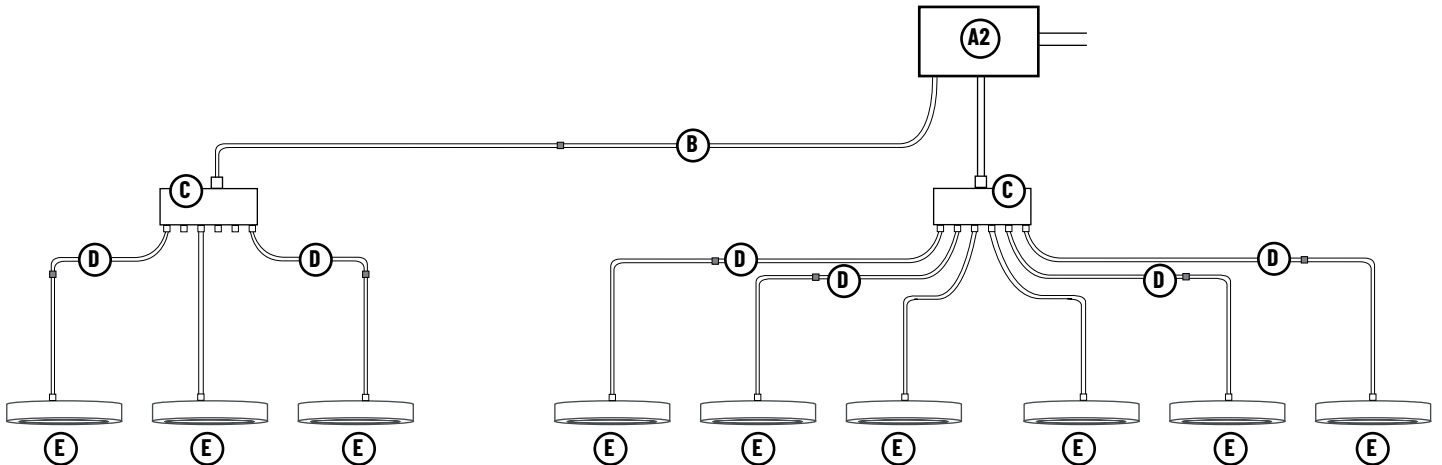

PHOTOMETRICS

24V Adjustable Josh LED Puck Light

Type

Project

Catalog No.

Notes

Test Information

Test Number: NTS178R1
 Part Number: NMP2-A27W
 Beam Spread: 113° Wide Flood
 Lumens: 291lm
 Wattage: 5.27W
 Efficacy: 55lpw
 CCT / CRI: 2700K / 90 CRI
 Spacing Criteria (0°-180°): 1.26
 Spacing Criteria (90°-270°): 1.26

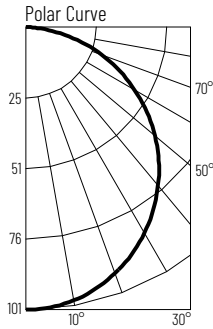

Illuminance at a Distance

Distance from Luminaire	FC at Nadir	Beam Diameter
4'	6.3fc	12"-2"
6'	2.8fc	18"-4"
8'	1.6fc	24"-5"
10'	1.0fc	30"-6"
12'	0.7fc	36"-7"

Zonal Lumen Summary

Zone	Lumens	% Luminaire
0-30	79	27.0
0-40	129	44.2
0-60	228	78.4
0-90	291	100
90-180	0	0
0-180	291	100

Candela Table

Vertical Angles	Candela
0	101
5	101
15	97
25	91
35	80
45	68

Test Information

Test Number: NTS179R1
 Part Number: NMP2-A30W
 Beam Spread: 113° Wide Flood
 Lumens: 312lm
 Wattage: 5.42W
 Efficacy: 58lpw
 CCT / CRI: 3000K / 90 CRI
 Spacing Criteria (0°-180°): 1.26
 Spacing Criteria (90°-270°): 1.26

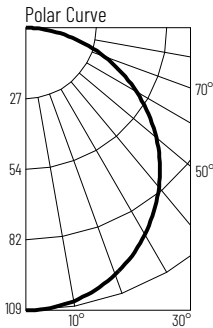

Illuminance at a Distance

Distance from Luminaire	FC at Nadir	Beam Diameter
4'	6.8fc	12"-2"
6'	3.0fc	18"-4"
8'	1.7fc	24"-5"
10'	1.1fc	30"-6"
12'	0.8fc	36"-7"

Zonal Lumen Summary

Zone	Lumens	% Luminaire
0-30	84	27
0-40	138	44.2
0-60	245	78.4
0-90	312	100
90-180	0	0
0-180	312	100

Candela Table

Vertical Angles	Candela
0	109
5	108
15	105
25	97
35	86
45	72

Test Information

Test Number: NTS180R1
 Part Number: NMP2-A35W
 Beam Spread: 113° Wide Flood
 Lumens: 307lm
 Wattage: 5.2W
 Efficacy: 59lpw
 CCT / CRI: 3500K / 90 CRI
 Spacing Criteria (0°-180°): 1.26
 Spacing Criteria (90°-270°): 1.26

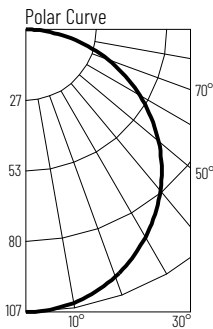

Illuminance at a Distance

Distance from Luminaire	FC at Nadir	Beam Diameter
4'	6.0fc	12"-2"
6'	3.0fc	18"-4"
8'	1.7fc	24"-5"
10'	1.1fc	30"-6"
12'	0.7fc	36"-7"

Zonal Lumen Summary

Zone	Lumens	% Luminaire
0-30	83	27
0-40	136	44.2
0-60	241	78.4
0-90	307	100
90-180	0	0
0-180	307	100

Candela Table

Vertical Angles	Candela
0	107
5	107
15	103
25	96
35	85
45	71

Test Information

Test Number: NTS181R1
 Part Number: NMP2-A40W
 Beam Spread: 113° Wide Flood
 Lumens: 317lm
 Wattage: 5.19W
 Efficacy: 61lpw
 CCT / CRI: 4000K / 90 CRI
 Spacing Criteria (0°-180°): 1.26
 Spacing Criteria (90°-270°): 1.26

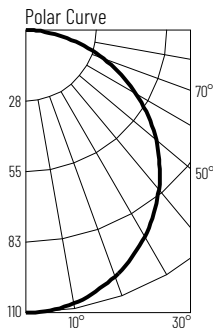

Illuminance at a Distance

Distance from Luminaire	FC at Nadir	Beam Diameter
4'	6.9fc	12"-2"
6'	3.1fc	18"-4"
8'	1.7fc	24"-5"
10'	1.1fc	30"-6"
12'	0.77fc	36"-7"

Zonal Lumen Summary

Zone	Lumens	% Luminaire
0-30	86	27
0-40	140	44.2
0-60	249	78.4
0-90	317	100
90-180	0	0
0-180	317	100

Candela Table

Vertical Angles	Candela
0	110
5	110
15	106
25	99
35	88
45	74