

# Installation Instructions

## NYLS3-6S

### 6" Surface Mounted Sapphire III Cylinder

**READ PRIOR TO ATTEMPTING INSTALLATION**  
**ALWAYS TURN OFF MAIN POWER BEFORE INSTALLATION**  
**INSTALLATION SHOULD BE CARRIED OUT BY YOUR LOCAL ELECTRICIAN**

**⚠ FIRE/ELECTRICAL HAZARD:** INSTALL ACCORDING TO NATIONAL ELECTRIC CODE AND ANY APPLICABLE MUNICIPAL CODE REQUIREMENTS. - This equipment is intended to be installed only by qualified personnel. The installation must be made in accordance with the current edition to the National Electric Code and all applicable state and local building codes. The final installation must be approved by the appropriate qualified electrical/building inspector(s). Improper installation may result in a fire or electrical hazard. Be sure the electrical power to the circuit has been disconnected before installing this electrical system.

**⚠ RISQUE D'INCENDIE / D'ÉLECTRICITÉ:** INSTALLER SELON LE CODE ÉLECTRIQUE NATIONAL ET TOUTES LES EXIGENCES RELATIVES AU CODE MUNICIPAL APPLICABLE. - Cet équipement est destiné à être installé uniquement par du personnel qualifié. L'installation doit être faite conformément à l'édition actuelle du Code national de l'électricité et de tous les codes de construction locaux et nationaux applicables. L'installation finale doit être approuvée par un ou plusieurs inspecteurs qualifiés en électricité / bâtiment. Une installation incorrecte peut entraîner un incendie ou un risque électrique. Assurez-vous que l'alimentation électrique du circuit a été déconnectée avant d'installer ce système électrique.

#### COMPATIBLE JUNCTION BOXES

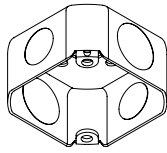

3" Octagonal

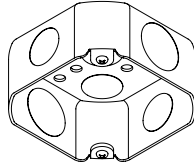

4" Octagonal

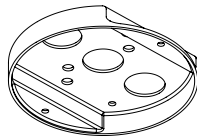

4" Pancake

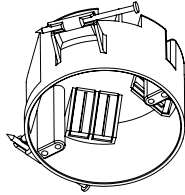

4" Plastic Round

#### ELECTRICAL CONNECTIONS

Connect wires accordingly:

- Black Wire = Live (Hot)
- White Wire = Neutral
- Green or Copper Wire = Grounding Junction Box Wire

0-10V Wiring:

- Purple = Dim (+)
- Pink or Grey = Dim (-)

**NOTE ON GROUNDING:** Many structures carry grounding via steel conduit. If this is the case, if there is no grounding wire, simply leave green wire on fixture unattached. Fixture will be grounded through attachment of conduit to junction box. However, if Romex or PVC conduit is used, ground wire will always be present, and must be connected to green wire on fixture junction box to avoid electrical shock hazard.

#### 120/277V CONNECTION:

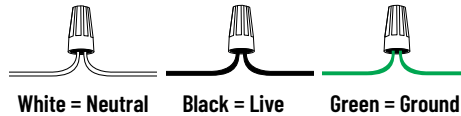

#### 0-10V DIMMING CONNECTION:

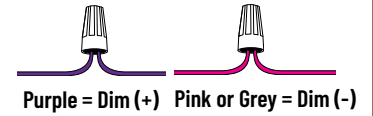

#### 0-10V DIMMING CONNECTION:

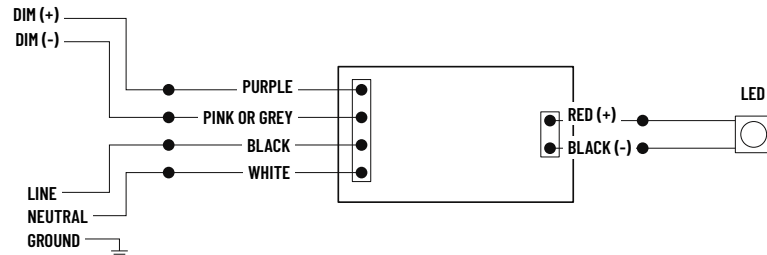

\* cap off 0-10V dimming wires if not used \*

# Installation Instructions

NYLS3-6S

6" Surface Mounted Sapphire III Cylinder

READ PRIOR TO ATTEMPTING INSTALLATION  
ALWAYS TURN OFF MAIN POWER BEFORE INSTALLATION  
INSTALLATION SHOULD BE CARRIED OUT BY YOUR LOCAL ELECTRICIAN

## SURFACE MOUNT INSTALLATION

1. Ensure electrical power is off.
2. Remove knockouts on cylinder cap. (Figure 1)
3. Insert power cord through nipple in cylinder cap. (Figure 2)
4. Make electrical connections inside junction box (not included). (Figure 3)  
Refer to "WIRING DIAGRAM" on page 2 to make the electrical connections.
5. Attach cylinder cap to junction box with screws (included). (Figure 4)
6. Attach cylinder to cylinder cap through keyhole slots. (Figure 5)
7. Twist the cylinder cap to lock the cylinder. Tighten screws inside cylinder. (Figure 6)
8. Connect CL2 cable from LED driver to Sapphire reflector. (Figure 7)
9. Secure Sapphire reflector to cylinder by screwing the aircraft cable to torsion blade.  
Make sure aircraft cable is pointing upwards. (Figure 8)
10. Push reflector into cylinder until flush.

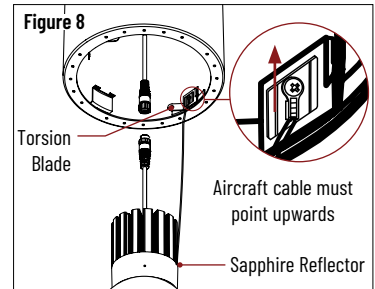
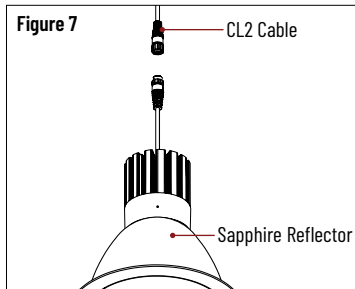
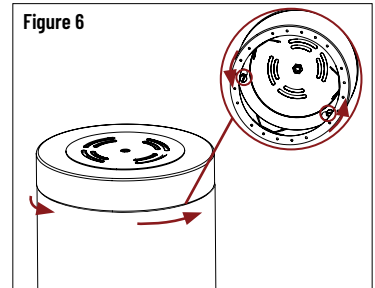
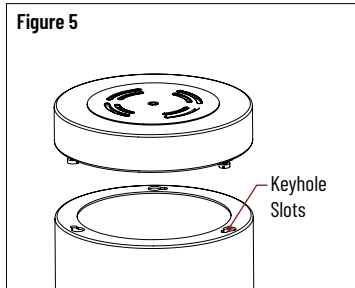
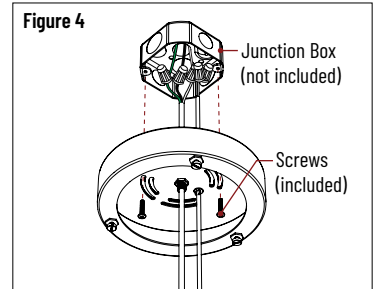
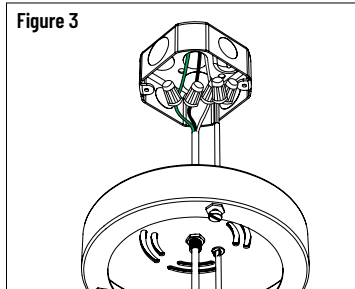
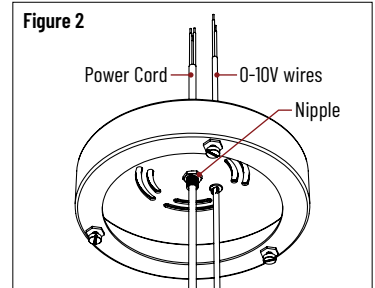
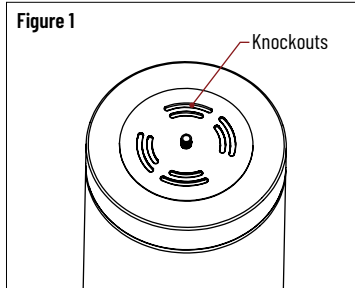
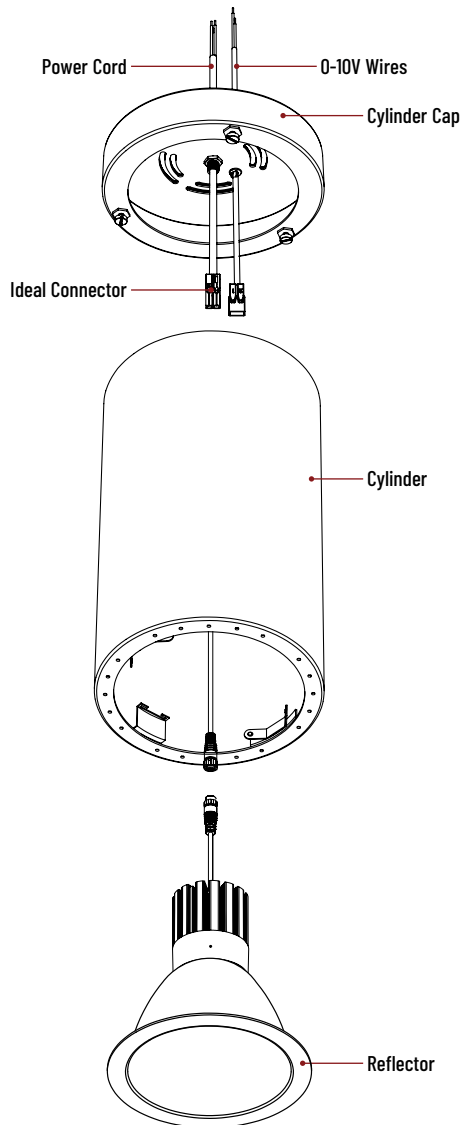

# Installation Instructions

NYLS3-6S

6" Surface Mounted Sapphire III Cylinder

READ PRIOR TO ATTEMPTING INSTALLATION  
 ALWAYS TURN OFF MAIN POWER BEFORE INSTALLATION  
 INSTALLATION SHOULD BE CARRIED OUT BY YOUR LOCAL ELECTRICIAN

**EMERGENCY CONNECTION (NEPK-07LEDUNV)**

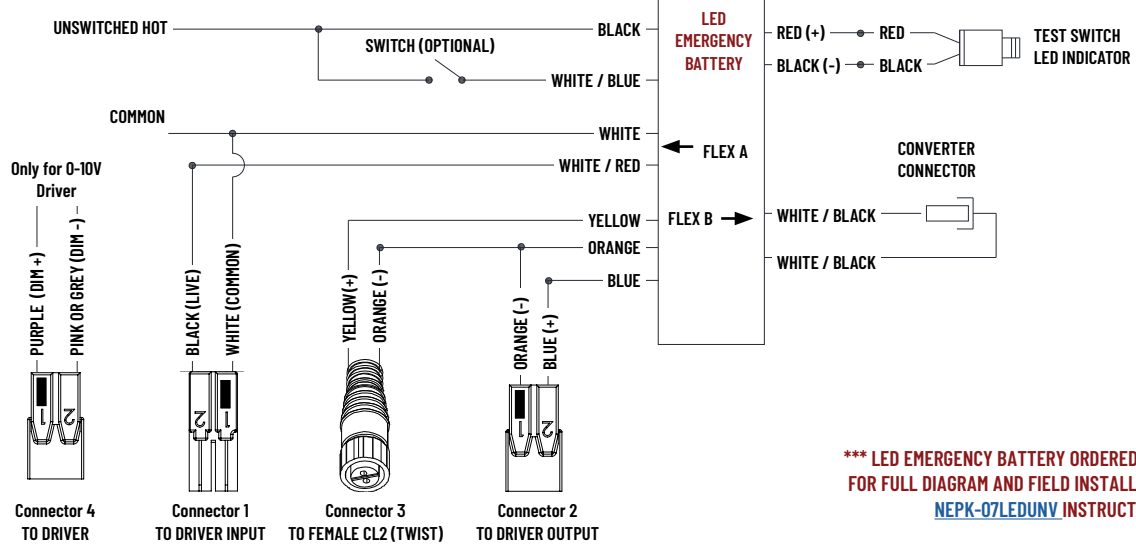

\*\*\* LED EMERGENCY BATTERY ORDERED SEPARATELY\*\*\*  
 FOR FULL DIAGRAM AND FIELD INSTALLATION, REFER TO  
[NEPK-07LEDUNV INSTRUCTIONS](#)

**CONNECTOR 1**

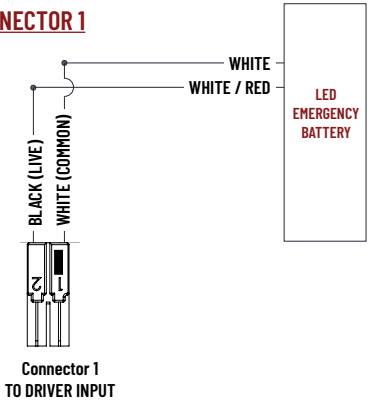

**CONNECTOR 2**

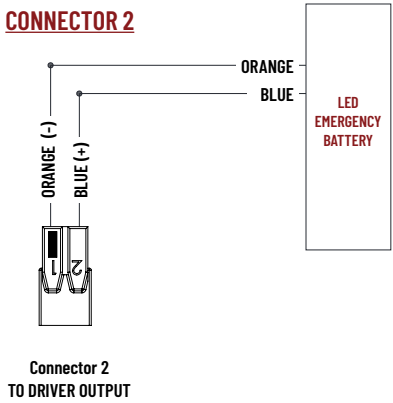

**CONNECTOR 3**

