

The logo for NORA LIGHTING is displayed in white text on a dark red background. The word "NORA" is in a large, bold, sans-serif font, with a registered trademark symbol (®) to its upper right. Below it, the word "LIGHTING" is written in a smaller, all-caps, sans-serif font. The background features a series of concentric white circles that create a tunnel-like effect, receding towards the right side of the page.

NORA[®]
LIGHTING

PRODUCT PREVIEW

1ST Quarter 2025

CONTRACTOR SERIES

Scan for more info.



Visit our
**Contractor Series
Webpage**

www.noralighting.com/contractor

Can-less LED Downlights

BULK PACK	12 per box	
SIZE	4"	6"
LUMENS / WATTAGE	850lm / 10W	1050lm / 12W



NCSC-R4D1TWMPW



NCSC-R6D1TWMPW

Can-less LED Wafer Downlights

BULK PACK	12 per box	
SIZE	4"	6"
LUMENS / WATTAGE	750lm / 10W	1050lm / 13.5W



NCSC-R4W2TWMPW



NCSC-R6W2TWMPW

LED Retrofit

BULK PACK	12 per box	
SIZE	4"	6"
LUMENS / WATTAGE	700lm / 10W	950lm / 12W



NCSR-R41TWMPW



NCSR-R61TWMPW

Surface Mount

BULK PACK	12 per box	
SIZE	6"	
LUMENS / WATTAGE	1200lm / 16W	



NCSD-R6TWMPW
(Selectable CCT)



NCSD-R630MPW
(Dedicated 3000K)

LED Backlit Panels

BULK PACK	4 per box	
SIZE	2' x 2'	2' x 4'
LUMENS / WATTAGE	3700lm / 30W	5700lm / 45W



NCSP-22/334W



NCSP-24/334W



Large enough to do it right, Small enough to care.

FAMILY OWNED BUSINESS SINCE 1989

Since our founding in 1989, Nora Lighting has grown from a small importer of lighting fixtures to a designer and manufacturer of quality LED and non-LED residential and commercial lighting. Our long-time customers and reps are familiar with our humble beginnings as a company and for those of you who are newer to Nora, this story is at the core of how we make choices and how we operate and thrive as a business.

Jilla and I fled Iran in 1987 as refugees and started Nora Lighting two years later in a 1,000 ft² office with only 4 SKU's. With no lighting background or business network in the US, we earned our customers' trust through honest business practices, exceptional service, and quality products. Our same core values of "Service, Quality, and Value" are still very much true today. Through tireless hard work with our amazing Nora team, we were able to expand our product offering, engineering capabilities, warehousing, and sales network to what it is today. We proudly boast a portfolio of over 40,000 SKUs and have our products stocked in over 300,000 ft² of warehouse space across the country.

In 2013, our daughter Neda joined our business to lead it into the second generation. We have supported this next generation of our business with large investments in company infrastructure, inventory, warehousing, and personnel. Our 100% cloud-based ERP system allows us and you to access real-time information from anywhere at any time and has increased our inventory accuracy to over 98% month-over-month. Our newly renovated R&D center is equipped with the latest technology and a UL certified lab. Our product offering, with its quality and pricing is unparalleled in our industry. Our warehouses are filled wall-to-wall with inventory and in 2022 alone, we added two new distribution centers and added two new sales territories to allow us to better serve our customers and reps.

We look forward to welcoming you to our new state-of-the-art showroom and training facility in Los Angeles. To know us is to understand our slogan of "large enough to do it right, small enough to care." We are a proud family-owned and operated business. Doing business with Nora means you come first because family always comes first.

Thank you for trusting us and supporting us over 36 years. We are confident that we have positioned ourselves for many more successful years.

A handwritten signature in black ink that reads "Fred Farzan".

Fred Farzan
President

Detachable Roof
Easy maintenance with
above ceiling access

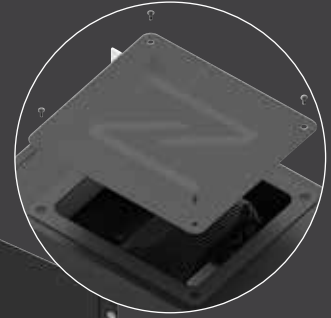

Precise Aiming & Locking
361° Rotation
45° Tilt



Extruded Aluminum Heat Sink
with COB LED technology

Field Changeable TIR Optics
10° Narrow Spot to 50° Narrow Flood

Romex Strain Relief
Accepts two NM cables



Reinforced Bar Hangers
with two locking positions

Field Changeable Collars
Accommodates ceiling
thickness from 0.5" to 2"

Mud Ring
Round or Square
Die-Cast Aluminum with
Knife Edge Appearance

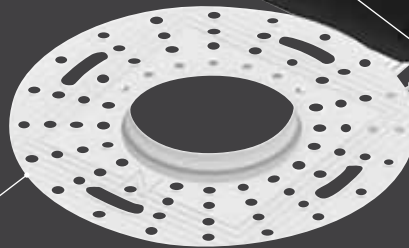

Die-Cast Reflectors
Downlight, Pinhole or Wall Wash
Flanged or Trimless / Millwork



NAPF-3RDN
Round Flanged Downlight
(shown with Haze finish)



NAPF-3RPH
Round Flanged Pinhole
(shown with Bronze finish)



NAPF-3RWW
Round Flanged Wall Wash
(shown with Wheat Diffused finish)



NAPT-3RDN
Round Trimless Downlight
(shown with Matte Powder White finish)



NAPT-3RPH
Round Trimless Pinhole
(shown with Bronze finish)



NAPT-3RWW
Round Trimless Wall Wash
(shown with Haze finish)



NHAPIC-3
Apollo IC Air-Tight
Housing

APOLLO

Scan for info.



LUMENS: 1000lm to 2500lm

COLOR TEMPERATURE: Dedicated



Introducing Apollo, three-inch recessed family featuring COB LED technology with variety of installation types, architectural grade finishes, TIR optics and dimming protocols. Flanged and trimless options are compatible in millwork applications with exceptional glare control.

Available Finishes:



Black

Bronze

Haze

Matte
Powder
White

Wheat
Diffused

FEATURES:

- Family of 3" luminaires in Round or Square (coming soon)
- Adjustable Mechanism (361° rotation / 45° tilt) without Glare
- Delivering 1000 to 2500 lumens
- Dedicated CCT options (2700K, 3000K, 3500K, 4000K)
- COB LED Technology with TIR Optics (10° to 50°)
- Phase, 0-10V, Lutron, DALI, Casambi Dimming down to 0.1%
- Flanged and Trimless Millwork Installations
- Accommodates ceilings up to 2" thick
- Five Architectural Grade Finishes
- cULus Listed for Wet Locations with Compatible Trims



Scan for info.



LUMENS: 900lm to 5500lm

COLOR TEMPERATURE: Dedicated

27K

30K

35K

40K

SAPPHIRE III

Architectural and Commercial
COB LED Downlights
New Construction, Can-less, Remodel

Sapphire III luminaires are a high efficiency, commercial series available in 900 to 5500 lumen packages in 2700K, 3000K, 3500K and 4000K at 90+ CRI. Luminaires utilize the latest COB technology by Signify®, allowing for better optic control offering three beam spreads. Beam spreads focus the light down to the work plane from high ceiling applications. Downlights are available in new construction, remodel and retrofit configurations. Each configuration is cULus listed for wet locations, ENERGY STAR certified and a 5-year limited warranty.



New Generation

Now delivering up to
5500 lumens!



NC3-41
4" Open Reflector



NC3-68
6" Decorative Glass



NCR3-61
6" Retrofit Open Reflector



NC3-86
8" Wall Wash



Universal Housing
has an Adjustable Collar
for Deep Ceilings



Scan for info.



LUMENS: 900lm to 4500lm

COLOR TEMPERATURE: Dedicated

27K

30K

35K

40K

ADJUSTABLE SAPPHIRE III

4", 6" and 8" LED Downlights
35° adjustment
IC and Non-IC New Construction Housing

Adjustable Sapphire commercial reflectors include a bias cut for precise adjustment up to 35°. Utilizing Signify® COB technology, downlights deliver from 900 to 4500 lumens in 2700K, 3000K, 3500K and 4000K at 90+ CRI. Adjustable luminaires are specified in three beam spreads to focus the light to the desired space. The fixtures have dedicated IC and Non-IC housings with 0-10V and Triac dimming, cULus listed, ENERGY STAR certified and a 5-year limited warranty.

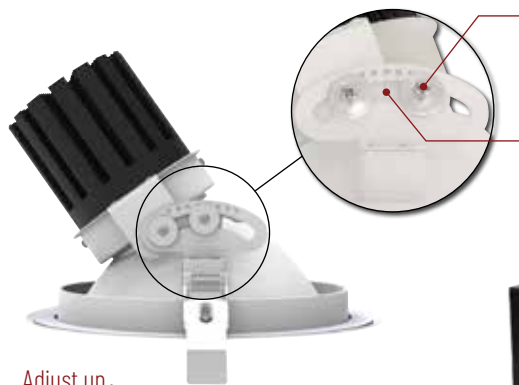

Locking Angle
Tighten screw to lock vertical angle

Adjustable Mechanism
Precise adjustment keeps light
source along axis. Graduation marks
for consistency.

Adjust up
to 35°

New Generation

Now delivering up to
4500 lumens!



NCHA3 / NCHAIC3
Adjustable Sapphire III
New Construction Housing



NC3-49
4" Adjustable



NC3-69
6" Adjustable



NC3-89
8" Adjustable



NRM3-43
4" Square



NRM3-59
5" Adjustable
Regressed Reflector

New Generation
Now delivering up to
2500 lumens!



NRM3-62
6" Baffle



NRM3-61
6" Retrofit Reflector



NRM3-6S2
6" Sloped Baffle



NHMIC3
New Construction Housing



NHRM3
Remodel Housing



NHMIC3-926
6" Sloped Housing

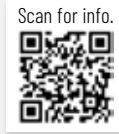

Scan for info.

LUMENS: 900lm to 2500lm
COLOR TEMPERATURE: Dedicated



MARQUISE III

Light Commercial / High-End Residential
COB LED Downlights
New Construction, Remodel, Retrofit

Utilizing the same Signify COB LED and driver packages as the Sapphire III, the Marquise III series features LED packages for light commercial and high-end residential IC and non-IC applications from 900 to 2500 lumens in 2700K, 3000K, 3500K and 4000K. Marquise III is available in 4", 5" and 6" reflector, adjustable, slope ceiling and Retrofit. The Marquise III uses the latest COB technology by Signify®, allowing for better optic control offering three beam spreads. Beam spreads focus the light down to the work plane from high ceiling applications. The Marquise III series is available in new construction, remodel and retrofit configurations.



Selectable Lumens
Three position sliding switch

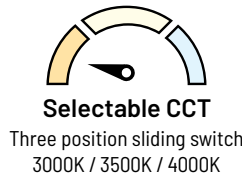

Selectable CCT
Three position sliding switch
3000K / 3500K / 4000K

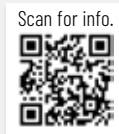

Scan for info.

LUMENS: 800lm to 3300lm
COLOR TEMPERATURE: Selectable



QUARTZ

Architectural and Commercial
Can-less LED Downlights
Retrofit old existing CFL & HID frame-ins

Quartz Series features two tunable switches located on the top of the driver unit on each luminaire; Selectable Lumens allows the end user to determine the wattage and Selectable CCT allows for selectable color temperature. Quartz series features LED packages from 800 to 3300 lumens in 3000K, 3500K or 4000K at 90+ CRI. Each downlight comes standard with matte powder white finish, optional snap-in reflectors in haze, specular clear and diffused clear finishes and oversized rings are available. The luminaires require no frame-in or housing, ideal for retrofit, new construction or remodel applications (new construction frame-ins are available). Fixtures are offered with universal input 120V-277V, 0-10V dimming, cETLus listed for wet locations, ENERGY STAR certified, and have a 5-year limited warranty.



NQZ2-41 (4")
NQZ2-61 (6")
NQZ2-81 (8")
Round Downlight

New Square
Now delivering up to
3300 lumens!



NQZ2-66 (6")
NQZ2-86 (8")
Square Downlight



NQZ
New Construction
Frame-Ins



Specular Clear
inserts & emergency
options now available

Scan for info.



LUMENS: 400lm or 600lm per head

COLOR TEMPERATURE: Dedicated

27K

30K

40K

M2 MULTIPLES

Modular Multiple Lighting System
Customizable with Four Trim Types
Each luminaire can deliver up to 600 lumens

Our M2 LED luminaires are now available in a Multiple Lighting System (MLS). The modular system requires components be ordered a la carte to create a recessed multiple. Available in **one, two, and three light** linear configurations, the units are completely serviceable from below and require **no housing**. M2 LED luminaires are available in **four round options** in 2700K, 3000K or 4000K and delivering up to 600 lumens. Each luminaire can be customized with accessories that include **pinhole trim, wall wash trim or reflector inserts**.



Dedicated LED Drivers
Allows each luminaire to be individually addressed

Quick Connect
Allows each luminaire to be individually addressed

No Housing Required
Recessed and IC Rated
One, Two or Three Head

Tension Steel Springs
Allow system to be installed in new construction or remodel applications

400 or 600 lumens per head
Downlight or Adjustable

Field Changeable Insert
Open downlight accepts baffle or reflector inserts

Field Changeable Trim
Matte Powder White and Matte Black finish

Scan for info.



LUMENS: 950lm to 3500lm per head

COLOR TEMPERATURE: Dedicated

27K

30K

35K

40K

FLANGED + TRIMLESS LED MULTIPLES

LED Dedicated or Medium Base PAR30
Multiple Lighting System
One to Three Head Configurations

LED dedicated MLS luminaires allow for adjustable lighting modules and pull-down adjustables in flanged and trimless styles. Offered in **one, two, and three light** linear configurations, the units are completely serviceable from below and can be specified in either **120V or 277V**. MLS can be wired as a single complete unit or as two to three individually controlled or dimmed modules.



New Generation

Now delivering up to 3500 lumens per head!



NMRG3-1 & NMRT3-1
Flanged MLS

The Flanged MLS LED fixtures produce **900 to 3500 lumen output** in 2700K, 3000K, 3500K or 4000K with specifiable beam spreads. The MLS face plate is regressed to maintain a clean ceiling appearance. Trim finishes are **white/white (shown), white/black, and silver/silver**.



NMRTL-12 & (2) NMRT-652TL
Trimless MLS

Trimless LED adjustable MLS produces **2100lm per gimbal** in 2700K, 3000K, 3500K or 4000K with specifiable beam spreads. The mud plates frame the housing with a clean sharp edge leaving a smooth flangeless appearance that blends in with the ceiling line. Flange kits and medium base version are also available.



NMRTL-13
Pull Down MLS
Shown with flange kit.

The Pull-Down units offer the ultimate in flexibility. Each LED module can be left in the housing and adjusted or can be pulled down partially or completely to gain full adjustability in aiming the fixture. Each module produces **2100 lumens at 90+CRI** in 2700K, 3000K, 3500K, or 4000K CCTs options. Available in **white or black finishes, flanged and trimless styles**, the MLS LED Pull-Down can be specified with spot or flood beam spreads.



LUMENS: 1000lm per head
COLOR TEMPERATURE: Dedicated

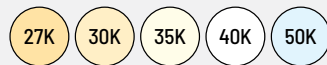

IOLITE MULTIPLES

1000lm per head
 One to Three Head Configurations
 Customizable with Four Trim Styles

The popular Iolite Downlight Series is available in multiple lighting system configurations. Iolite MLS is customizable in **one, two, and three light** linear configurations with **four different trim types—downlight, adjustable snoot, adjustable gimbal or wall wash.** Trims can be installed with **painted flange or trimless clean appearance.** The IC rated housing is completely serviceable from below and includes individual **120V-277V Triac/ELV/0-10V drivers for each module.**

Iolite MLS Series LED dedicated units feature COB LED technology. Each individual luminaire produces **over 1000 lumens in 2700K, 3000K, 3500K, 4000K, 5000K or 800lm with Comfort Dim technology.** Trim finishes include **matte powder white, black or haze and trim options are customizable.** Each trim includes three field-adjustable optics, optional premium TIR optics are available. Trims can be re-arranged in the field to desired configuration and adjustment.

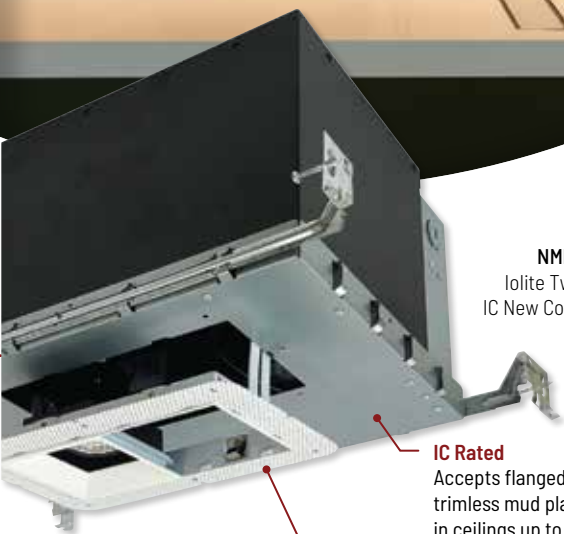

NMH10IC-12LE4
 Iolite Two Head Multiple
 IC New Construction Housing

IC Rated
 Accepts flanged and trimless mud plate in ceilings up to 1-1/2"

Flanged or Trimless
 Painted flange or trimless mud plate in one, two or three heads

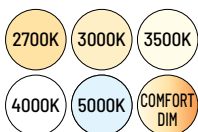

Die-Cast Aluminum Heat Sink
 with COB LED technology

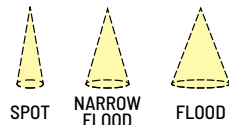

Field Changeable Optics
 Each module includes spot, narrow flood and flood optics



Four Trim Styles
 available in Fixed Downlight, Adjustable Snoot, Adjustable Gimbal & Wall Wash in variety of finishes



NMIOTL-11
 Trimless One Head



NMIOT-11
 Flanged One Head



NMIOTL-12
 Trimless Two Head



NMIOT-12
 Flanged Two Head



NMIOTL-13
 Trimless Three Head



NMIOT-13
 Flanged Three Head

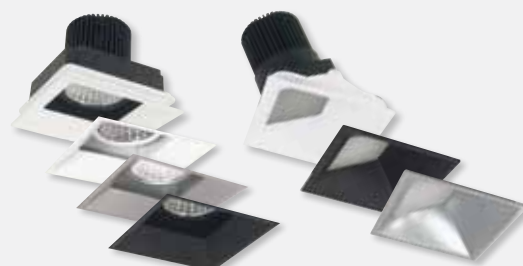

Fixed Downlight

Wall Wash

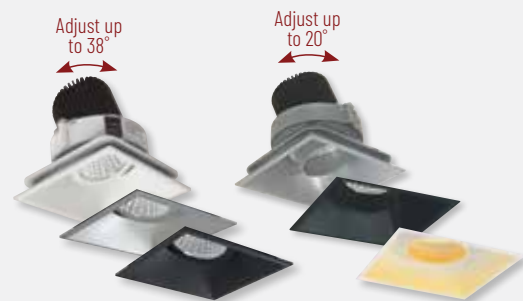

Adjust up to 38°

Adjust up to 20°

Adjustable Gimbal



Adjustable Snoot

Scan for info.



LUMENS: 600lm to 2500lm

COLOR TEMPERATURE: Dedicated



IOLITE DEDICATED

1", 2" and 4" LED Downlights
Dedicated and Retrofit
800 to 2500 Delivered Lumens

Iolite family is a series of 1", 2", and 4" dedicated and 4" retrofit LED adjustable downlights in square and round apertures. This modular die-cast aluminum system features the patented, easy, no-tool-required replacement of the driver, COB LED technology and one of the largest trim selections in the industry. The reflectors have sharp, clean edges and can be aimed down for general lighting or adjusted to highlight or wall wash a focal point. Each luminaire includes three field adjustable optics and accept optional accessories to customize each application.

Iolite LED modules delivers 600lm (1") or 800-2500lm (2" and 4") in various kelvin temperatures (2700K to 5000K) or Comfort Dim (3100K-2000K). Housings include an IC Air-Tight New Construction, Chicago Plenum, Remodel or 4" Retrofit. Dimming drivers include Lutron EcoSystem®, 0-10V, Triac or ELV and emergency options.



NIO-BLED109
10° LED Module
for 2" and 4"



NIO-4RNB
4" Round Bullnose

10° Optic
Available



Dedicated Housing
IC Air-Tight Rated

NHIOICD Series
2" and 4" High Lumen
New Construction Housings

ComfortDim
Recreate the Sunset with LED
New High Lumen Comfort Dim
3000K down to 2000K
Up to 2450 lumens!

Patented Driver Assembly
Slide tray allows for tool-less
removal of driver.
DALI dimming now available!

Die-Cast Heat Sink
COB LED technology

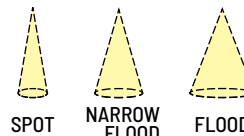

Field Changeable Optics
Each module includes spot,
narrow flood and flood optics

Optional Accessories
Can be added anytime
between trim & module



NIOB-1RPH
1" Fixed Pinhole

NIOB-2SC
2" Square Adjustable Cone

NIO-4RW
4" Wall Wash

New 4" Adjustable Trim
NIO-4RSLA
4" Adjustable Slot



NIO-4SNDC
4" Round Downlight



Scan for info.



LUMENS: 900lm to 2500lm

COLOR TEMPERATURE: Dedicated



IOLITE TRIMLESS

2" and 4" Round and Square Reflectors
New 4" Flange accessory for trimless

Iolite Trimless has no exposed trim flange and does not extend below the ceiling plane. This clean and sophisticated look is accomplished by mudding the trimless mud ring to the ceiling, then snapping the trimless reflector into the ring. **Iolite Trimless** is available in 2" and 4" round or square apertures. 4" PLUS series features **round and square adjustable and fixed downlight**. Trimless requires three parts: Iolite Housing, Mud Ring and Reflector. Each trimless delivers from **800 to 2500 lumens** in various kelvin temperatures (2700K to 5000K) or **Comfort Dim** (Warm Dim).



Dedicated Housing
Patented driver assembly allows for tool-less removal

Mud Ring
Round or Square
Die-Cast Aluminum



New High Lumen Comfort Dim
Die-Cast Heat Sink
COB LED technology

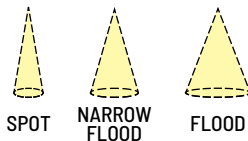

Field Changeable Optics
Each module includes spot, narrow flood and flood optics



NIO-2RTL A
2" Adjustable



NIO-4STL NDC
4" Downlight



NIO-4RTL NDC / NIO-4RTFA
4" Round Downlight with
Flange Accessory



NIO-4RTFA
4" Trimless Flange
Accessory



NIO-4RTSLA
4" Round Adjustable Slot



NIO-4PRTL A
4" PLUS Adjustable



NIO-4PRTL NDC
4" PLUS Downlight



NIO-4PSTLA
4" PLUS Adjustable



NIO-4PSTL NDC
4" PLUS Downlight

Scan for info.



LUMENS: 900lm to 1250lm

COLOR TEMPERATURE: Dedicated

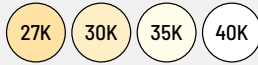

IOLITE CAN-LESS

1", 2" & 4" LED Downlights
No Housing Required!
Three Field Changeable Optics included

Award winning Iolite small aperture LED downlights are now available without any recessed housings. Simply cut the ceiling, wire the junction box and insert the luminaire in the ceiling cavity. IC Air-Tight rated luminaires are available in round or square apertures in a variety of styles and finishes. Available in three aperture sizes and up to 1250 lumens in dedicated color temperatures. Each LED module includes three field changeable optics to customize each application. Dedicated color temperatures include 2700K, 3000K, 3500K, 4000K or Comfort Dim (warm dimming).



NJCB-09
1" Remote Driver

NIOC-1LED
1" LED Module
(optics included)



NJCB-12
2" & 4" Remote Driver

NIOC-24LED
2" & 4" LED Module
(optics included)



120V Input
Triac or ELV dimming

Quick Connects
Easy installation in
IC Air-Tight installations

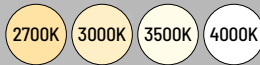

Dedicated CCT
COB LED technology

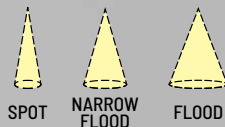

Field Changeable Optics
Each module includes spot,
narrow flood and flood optics

Six Trim Styles
Downlight, Adjustable, Bullnose,
Pinhole, Square & Sloped
in variety of finishes



WET NIOC-1RNB
1" Bullnose

WET NIOC-2RND
2" Downlight

WET NIOC-2RPH
2" Pinhole



NIOC-4RSLA
4" Adjustable

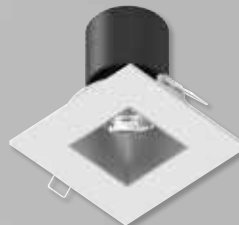

WET NIOC-4SNSQ
4" Square Downlight



New Sloped Ceiling Trim!
WET NIOC-4RSP
4" Sloped Downlight



New Adjustable Trim!
NPR-4RSLA
4" Adjustable Slot

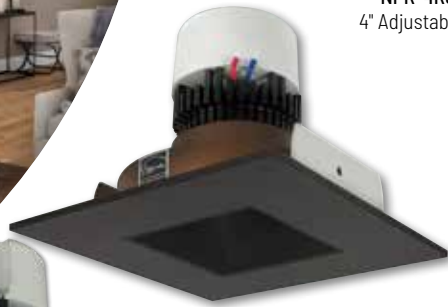

NPR-4SNSQ
4" Square Reflector w/
Square Aperture



NPR-56RND
5"/6" Round Reflector



Medium Base Socket
included with each luminaire
for easy retrofitting

Integral Driver
120V input
Triac / ELV dimming



Dedicated CCT
COB LED technology

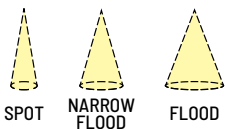

Field Changeable Optics
Each module includes spot,
narrow flood & flood optics

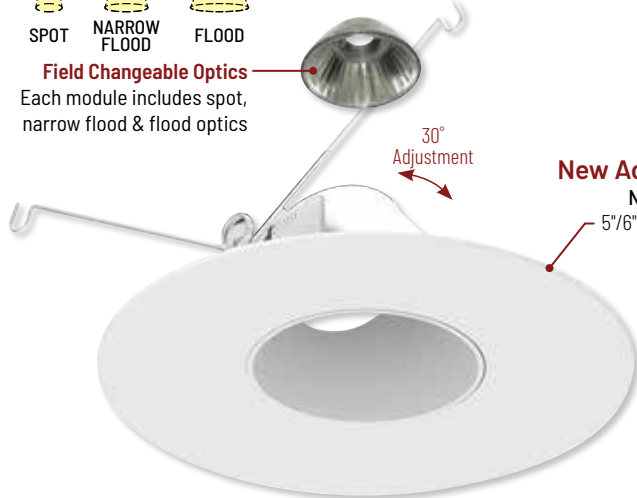

New Adjustable Trim!
NPR-56RSLA
5"/6" Adjustable Slot

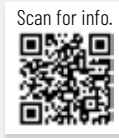

LUMENS: 1000lm to 1200lm
COLOR TEMPERATURE: Dedicated

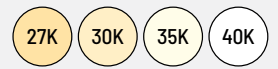

PEARL RETROFIT

4", 5" & 6" Round and Square Reflectors
Up to 1200 lumens & fits shallow housings

Pearl LED Retrofit luminaires are the high-end, quality solution for easy LED retrofitting in residential and light commercial applications. With a maximum **height of just 4-1/2"**, luminaires can be retrofitted in most 4" IC and non-IC housings—including **shallow!** Available in a beautiful array of fixed and adjustable styles in ten finishes, each Pearl includes three **field changeable optics** for maximum design control. Optional accessories can further customize the fixtures.



NPR-4RC
4" Adjustable Cone



NPR-4SC
4" Square Adjustable
Cone



NPR-4RG
4" Adjustable Gimbal



NPR-4SG
4" Square Adjustable
Gimbal



WET
NPR-4RNB
4" Bullnose



WET
NPR-4SNB
4" Square Bullnose



WET
NPR-4RND
4" Reflector



NPR-4RPH
NPR-4RPHA
4" Pinhole



NPR-4RSLA
4" Adjustable Slot



NPR-4RSL
4" Adjustable
Slot Aperture



WET
NPR-4SNSQ
4" Square Reflector



WET
NPR-4SND
4" Square Reflector w/
Round Aperture



WET
NPR-56RND
5"/6" Reflector



NPR-56RSLA
5"/6" Adjustable Slot

Scan for info.



LUMENS: 1000lm to 1200lm

COLOR TEMPERATURE: Dedicated

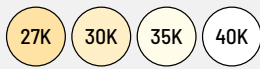

PEARL LOW VOLTAGE

4", 5" & 6" 12V Round and Square Trims
Up to 1200 lumens & fits shallow housings

Pearl low voltage LED retrofit luminaires are a high grade solution to replacing old MR16 lamps. A built-in driver converts the 12V voltage into a specification grade downlight with **three field changeable optics** for maximum design control. With a maximum **height of just 4-1/2"**, luminaires can be retrofitted in most 4" IC and non-IC housings--including **shallow!** Available in a beautiful array of fixed and adjustable styles in ten finishes. Optional accessories can further customize the fixtures.



NPRLV-4RC
4" Adjustable Cone



NPRLV-4SC
4" Square Adjustable Cone



NPRLV-4RG
4" Adjustable Gimbal



NPRLV-4SG
4" Square Adjustable Gimbal



WET **NPRLV-4RNB**
4" Bullnose



WET **NPRLV-4SNB**
4" Square Bullnose



WET **NPRLV-4RND**
4" Reflector



NPRLV-4RPH
NPRLV-4RPHA
4" Pinhole



NPRLV-4RSLA
4" Adjustable Slot



NPRLV-4RSL
4" Adjustable Slot Aperture



WET **NPRLV-4SNSDQ**
4" Square Reflector



WET **NPRLV-4SNDC**
4" Square Reflector w/
Round Aperture



WET **NPRLV-56RND**
5 1/6" Reflector



NPRLV-56RSLA
5 1/6" Adjustable Slot



NPRLV-4SG
4" Square Adjustable Gimbal



NPRLV-56RND
5 1/6" Round Reflector



GU5.3 Socket Adapter
hardwired to each luminaire for easy retrofitting in low voltage housings

Integral Driver
Triac / ELV dimming

Die-Cast Aluminum Heat Sink
with COB LED technology

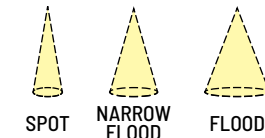

Field Changeable Optics
Each module includes spot, narrow flood and flood optics

Optional Accessories
can be added anytime between trim and LED module

30° Adjustment



New Adjustable Trims!

NPR-4RSLA (4")
NPR-56RSLA (5 1/6")
Adjustable Slot



Scan for info.



LUMENS: 800lm

COLOR TEMPERATURE: Selectable



ONYX LOW VOLTAGE

4" 12V Low Voltage Retrofit
Selectable CCT (27K/30K/35K/40K/50K)
Reflector & Baffle Trims

Onyx Low Voltage Retrofit Series is an economical and quality luminaire compatible with existing, new construction or remodel low voltage housings. 4" downlights produce over 800 lumens and include a Selectable CCT switch to **select the color temperature from 2700K / 3000K / 3500K / 4000K / 5000K**. An integrated driver converts the voltage from 12V and dimmable with compatible Triac or ELV dimmers

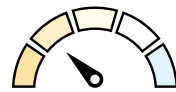

Selectable CCT

Five position sliding switch
27K / 30K / 35K / 40K / 50K

GU5.3 Socket Adapter
Easy retrofit in
low voltage housings

Integral Driver
Triac / ELV dimming

Trim Types
Reflector or Baffle
White finish



NOXLV-4R1
4" Reflector



NOXLV-4R2
4" Baffle

Scan for info.



LUMENS: 650lm to 1300lm

COLOR TEMPERATURE: Selectable



FLIN

4" and 6" Can-less Wafer Downlights
Round or Square Aperture
Selectable CCT (27K/30K/35K/40K/50K)

FLIN thin regressed downlights offer **quick, economical recessed IC Air-Tight LED lighting** for remodel or new construction applications. Simply cut the hole, wire the junction box, and insert FLIN using the spring coiled pressure clips which secure it tightly to the ceiling. **No housing is required!** FLIN is now available in 120-277V input and produces up to **1300 lumens** with a **Selectable CCT** switch (27K/30K/35K/40K/50K). The regressed lens with sharp baffle cuts reduces aperture brightness. FLIN series requires **less than 2"** ceiling clearance. A new construction frame-in plate and oversize ring available.

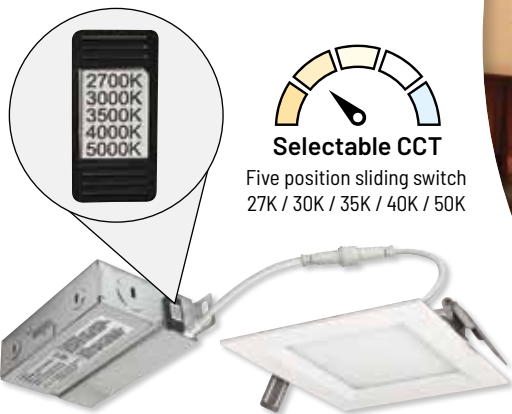

NEFLINTW-S4MPW
4" Square



NEFLINTW-R6MPW
6" Round



NF-R246
Universal New Construction
Frame-In for 4" & 6" Round



NFP-S245 / NFP-S625
Universal New Construction Plates



Scan for info.



LUMENS: 800lm or 1100lm

COLOR TEMPERATURE: Selectable



FLIN ADJUSTABLE

4" and 6" Can-less Wafer Downlights
25° Adjustment & 180° Rotation
Selectable CCT (27K/30K/35K/40K/50K)

FLIN Adjustable can-less downlights **adjust up to 25°** with the same appearance as FLAT downlights. IC Air-Tight rated luminaires require **no housing** and **rated for wet locations**. Delivering up to **1100 lumens** with a **Selectable CCT** switch (2700K / 3000K / 3500K / 4000K / 5000K) switch built-in to the remote junction box.

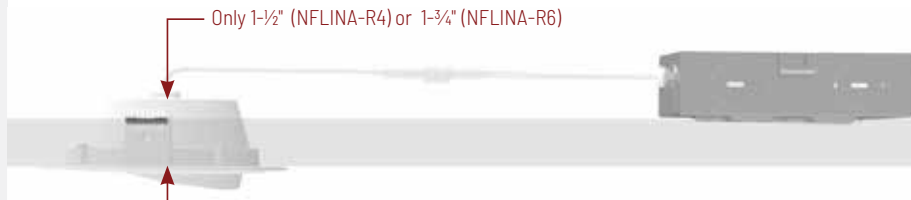

Selectable CCT
Five position sliding switch
27K / 30K / 35K / 40K / 50K



NFLINA-R6TWPW
6" FLIN Adjustable



NFLINA-R4TWPW
4" FLIN Adjustable



NFC-R430 (4")
NF-R246 (6")
New Construction Frame-In





Selectable CCT
Five position sliding switch
27K / 30K / 35K / 40K / 50K

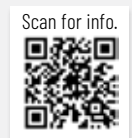

LUMENS: 700lm or 1050lm
COLOR TEMPERATURE: Selectable

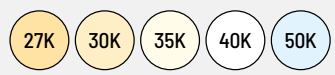

1/2" depth

NFLAT-R6TWMPW
6" FLAT



New Black Finish!
NFLAT-R6TWB
6" FLAT

FLAT

4" and 6" Can-less Wafer Downlights
Dead Front Trim (Non-Metallic)
Selectable CCT (27K/30K/35K/40K/50K)

FLAT wafer can-less downlights feature a **non-metallic trim** for corrosive environments. IC Air-Tight rated luminaires are similar to our existing FLIN series, where **no housing is required** and **only 1/2" height**. Delivering up to **1050 lumens** with a **Selectable CCT** switch (2700K / 3000K / 3500K / 4000K / 5000K) switch built-in to the remote junction box.



NF-R246
Universal New Construction
Frame-In



New 0-10V Option
120-277V input
0-10V dimming



NLTH-41TW-MPW
4" Theia



NLTH-61TW-MPW
6" Theia



New Haze Finish!
NLTH-81TW-HZMPW
8" Theia

Selectable CCT
Five position sliding switch
27K / 30K / 35K / 40K / 50K

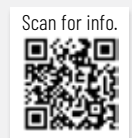

LUMENS: 950lm to 2100lm
COLOR TEMPERATURE: Selectable

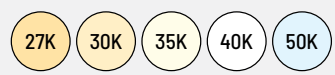

THEIA

4", 6" & 8" Can-less Downlights
with Deep Reflector
Selectable CCT (27K/30K/35K/40K/50K)

Commercial grade downlights without any frame-in or housing required. Each luminaire includes a dedicated junction box with **integral CCT switch**. 4" (950lm), 6" (1400lm) and 8" (2100lm) downlights are IC air-tight rated, include **five color temperatures** (27K / 30K / 35K / 40K / 50K) and dimmable with compatible phase or 0-10V dimmers. Wet location rated luminaires are ideal for variety of applications indoor or outdoor.



NEPK-20LEDUNV
20W Emergency LED Driver

Scan for info.



LUMENS: 750lm or 1250lm

COLOR TEMPERATURE: Dedicated

27K

30K

M-WAVE

Adjustable Can-less Downlights
90° Tilt & 350° Rotation
Dedicated CCT (2700K or 3000K)

M-Wave can-less luminaires offer the most versatility for aiming without any housing needed! IC Air-Tight rated luminaires extend up to 90° from surface and rotate 350°, illuminating any direction needed. M-Wave downlights appear as puck lights, up to 1-3/8" off the surface when flush and delivering over 1250 lumens in dedicated CCT (2700K or 3000K).



NMWA-OPT
Field Changeable
Optics

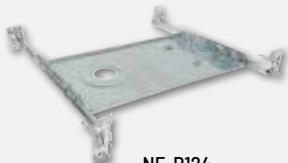

NF-R124
Universal New Construction
Frame-In for 4"

Scan for info.



LUMENS: 900lm or 1300lm

COLOR TEMPERATURE: Selectable

27K

30K

35K

40K

50K

M-CURVE

Adjustable Can-less Downlights
Extends up to 80° & 360° Rotation
Selectable CCT (27K/30K/35K/40K/50K)

M-Curve can-less adjustable downlights are a unique and functional. Extending 80° while never exposing the ceiling aperture. IC Air-Tight rated luminaires extend up to 80° and rotate 360°, illuminating any direction needed. Delivering up to 1300 lumens with a Selectable CCT (2700K / 3000K / 3500K / 4000K / 5000K) switch built-in to the remote junction box.



NF-R375 (4")
NFC-R5 (6")
New Construction Frame-In



NMW-2
2" M-Wave

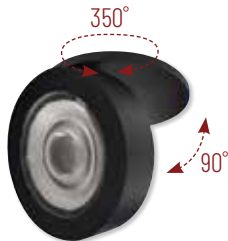

NMW-4
4" M-Wave

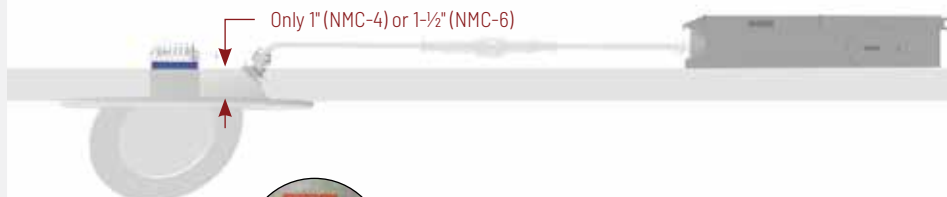
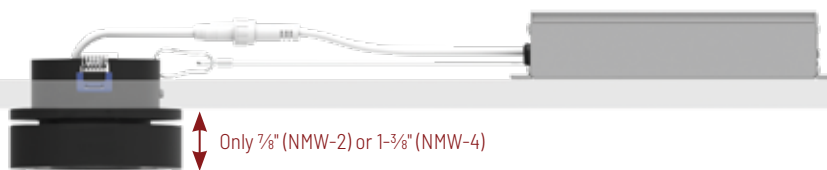

NMC-4RTWMPW
4" M-Curve

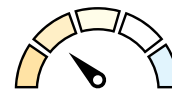

Selectable CCT

Five position sliding switch
27K / 30K / 35K / 40K / 50K



NMC-6RTWMPW
6" M-Curve





NM1-170
M1 Module and 4 Plastic Trims



NM1-SSS
Square Stainless Steel



NM1-RSS
Round Stainless Steel



NM1-RAEYELID
Round Scoop



NM1-RLouv
Round Louver



NM1-RAIHEC
Round Hex Louver



NM1-RSSD
Round Stainless Steel Indicator

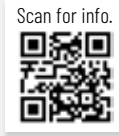

Scan for info.

LUMENS: 100lm

COLOR TEMPERATURE: Dedicated



M1

1" 12V Can-less Downlights
No housing required • IC rated
Field Changeable Trims & Optics

M1 miniature 1" recessed downlights features quality and convenience with easy installation for indoor and outdoor applications. LED luminaires **include four plastic downlight trims**, four optics and 6" quick connect for **12V driver**. **No housing is required** and can be installed in insulated ceilings. Field changeable optics and trims allow for each installation to be customized per application. LED luminaires delivers **100 lumens** and available in **2700K or 3000K** at 90+ CRI and requires a 12V dimmable driver. New construction rough-in plate available.

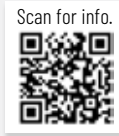

Scan for info.

LUMENS: 600lm

COLOR TEMPERATURE: Dedicated



NM1-PRDC & NM1-PSDT
1" M1+ w/ Square Trim



NM1-PRDCMPW
1" M1+ Downlight

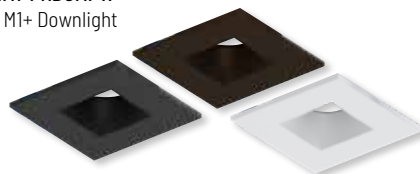

NM1-PSDT
Square Trim

M1+

1" 120V Can-less Downlights
No housing required • IC Air-Tight
600lm / 9W • Square Trim Accessory

M1+ is an upgrade to our first generation M1 1" downlights. From 12V input to 120V input with Triac or ELV dimming. From 100 lumens to 600 delivered lumens. Die-cast trims come standard in round matte black or matte powder white finishes. Luminaires include a pre-wired junction box, no housing is required. IC Air-Tight rated luminaires are simple to install.

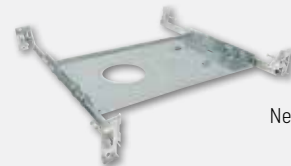

NF-R2
New Construction Frame-In



Scan for info.



LUMENS: 400lm to 900lm

COLOR TEMPERATURE: Dedicated

27K

30K

40K

M2

2" 120V Can-less Downlights No housing required • IC Air-Tight Trimless and Flanged Options

M2 recessed downlights do not require a housing, which makes installation easy. Simply cut the ceiling, wire the junction box and insert the luminaire in the ceiling cavity. IC rated luminaires are available in **round or square trims in a variety of styles including downlight, shower, adjustable gimbal, elbow, pinhole, wall wash and baffle** and are customizable with accessories. Delivering over **900 lumens in 2700K, 3000K or 4000K at 90+ CRI**. New construction frame-in and extension cables are available.



NM2-2RDC
Round Downlight



NM2-2RDCS
Lensed Downlight



NM2-2RDC
Round Downlight



NM2-2RG
Round Gimbal



NM2-2SDC
Square Downlight



NM2-2SB
Square Baffle



MLS Multiple Plate
Accessories



Square Trim
Accessories

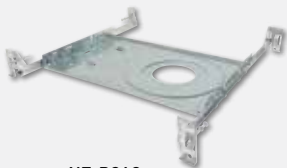

NF-R246

Universal New Construction
Frame-In



Baffle & Reflector
Inserts



Mud Plate
Installs against drywall
without any housing

120V Input
Triac or ELV dimming

Quick Connects
Easy installation in
IC Air-Tight installations

Patent Pending
Steel plates hold trimless against
magnet inside mud plate

Dedicated CCT
2700K, 3000K or 4000K*
* Select trims

2700K 3000K 4000K

NM2-2RTLDC
Trimless Downlight



Trimmed appearance
available in matte black and
matte powder white



Knife edge trimless appearance
with no exposed flange

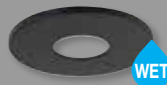

NM2-RPH
Pinhole Trim



NM2-2RDCS
Lensed Downlight



NM2-RW
Wall Wash Trim



Scan for info.



LUMENS: 950lm to 1150lm
COLOR TEMPERATURE: Dedicated



M4

4" 120V Can-less Downlights
 No housing required • IC Air-Tight
 Adjustable, Elbow and Downlight Options

M4 4" recessed downlights resemble other can-less downlights (M1 and M2). Luminaires include a pre-wired junction box, no housing is required. IC Air-Tight rated luminaires are simple to install with round or square trims in a variety of styles including downlight, adjustable gimbal or elbow. Delivering up to 1150 lumens in 2700K or 3000K at 90+ CRI. New construction frame-ins and extension cables are available.



NM4-RG
 4" Adjustable Gimbal



NM4-RDC
 4" Downlight



NM4-RDC & NM4-SDT
 Downlight w/ Square Trim



NM4-R470
 4" Adjustable Elbow

NM4-R470 & NM4-SET
 Elbow w/ Square Trim



NM4-SET
 Square Baffle Trim for NM4-RDC



NM4-SET
 Square Trim for NM4-R470

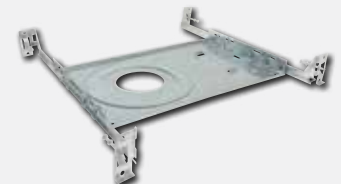

NF-R246 (NM4-RG & NM4-R470)
NFC-R375 (NM4-RDC)
 New Construction Frame-In

Scan for info.



Patent Pending

4" JUNCTION BOX

IC Air-Tight Recessed Housing
(Compatible with 4" AC Onyx, Pearl, Slim
and Cobalt Click w/ Selectable CCT)

Dedicated new construction housing for use in insulated ceilings can be in direct contact with insulation. Powder coated steel housing meets 2 hour fire rating per international building code section 714 for 1-hour and 2-hour fire rated assemblies. Air-tight construction provides energy savings by reducing the flow of air through the ceiling. The housing is labeled for use with LED downlights or as an outlet box.



NFJB-R4
4" Junction Box for fire rated assembly



New Surface Mount Version
NFJB-R4S
with pre-installed brackets

Ceiling Thickness
Accommodates 1/2" to 1-1/2" ceilings

Only 4" Height
for shallow ceiling
plenums, under 3-1/2"
when used in 1/2" ceiling

Adjustable Bar Hangers
extend up to 25-5/8" with
captive nails and alignment foot

Alignment Notch
for use with laser level

COMPATIBLE LUMINAIRES

Cobalt Click



NLCBC2-451TW
Cobalt Click Reflector
w/ Selectable CCT



NLCBC2-452TW
Cobalt Click Reflector
w/ Selectable CCT

Pearl Retrofit

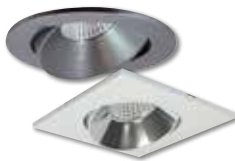

NPR-4RC / NPR-4SC
Pearl Adjustable Cone



NPR-4RG / NPR-4SG
Pearl Adjustable Gimbal



NPR-4RNB / NPR-4SNB
Pearl Bullnose

AC Onyx



NOXAC-431TWWW
AC Onyx Reflector



NOXAC-432TWWW
AC Onyx Baffle



NOXAC-4RGTWWW
AC Onyx Adjustable



NOXAC-4RWTWWW
AC Onyx Round Wall Wash



NOXAC-4SWTWWW
AC Onyx Square Wall Wash

Slim Downlights



NSLIM-4RL1TWMPW
Slim Surface Mount



NSLIM-4REGL1TWMPW
Regressed Slim
Surface Mount



Retrofit Kit included
for 4" recessed housings



Surface Mount
over 4" octagonal junction box



NSLIM-4RL1TWPW
4" Slim Surface Mount

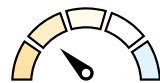

Selectable CCT
Five position switch
27K / 30K / 35K / 40K / 50K



Scan for info.

LUMENS: 800lm
COLOR TEMPERATURE: Selectable



SLIM

LED Surface Mount / Retrofit
Optional Decorative Trim Rings
Selectable CCT (27K/30K/35K/40K/50K)

Slim LED surface mount luminaires easily install over 4" octagonal junction boxes. Alternatively an optional retrofit kit is also included to install over 4" recessed housings. Luminaires produce over 800 lumens and include a selectable CCT switch to change the color temperature from 2700K / 3000K / 3500K / 4000K / 5000K.



NSLIM-4RDTB
Black Ring



NSLIM-4RDTS
Silver Ring

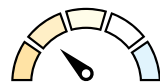
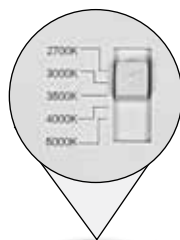

Selectable CCT
Five position switch
27K / 30K / 35K / 40K / 50K



New Regressed Slim
NSLIM-4RLEG1TWPW
4" Surface Mount



Scan for info.

LUMENS: 950lm
COLOR TEMPERATURE: Selectable



REGRESSED SLIM

LED Surface Mount
Selectable CCT (27K/30K/35K/40K/50K)

Ultra slim regressed LED surface mount luminaires easily install over 4" octagonal junction boxes. Regressed light source gives the appearance of a recessed luminaire while producing 950 lumens. Selectable CCT switch to change the color temperature from 2700K / 3000K / 3500K / 4000K / 5000K.



Scan for info.



LUMENS: 750lm to 1150lm

COLOR TEMPERATURE:

Dedicated or Selectable

27K

30K

35K

40K

50K

AC ONYX DOWNLIGHTS

4", 5" and 6" Retrofit Downlights
Round or Square Aperture
Dedicated or Selectable CCT

Onyx LED retrofit downlights feature designer trim types (baffle, reflector and square) with simple installation and quality. Options include **dedicated or selectable color temperature** and trim inserts to change finish or trim type. Die-cast aluminum construction provides clean sharp edges and is suitable for use with most 4", 5" and 6" recessed housings.



NOXAC-431 (Dedicated CCT)
NOXAC-431TW (Selectable CCT)
4" Reflector



NOXAC-432 (Dedicated)
NOXAC-432TW (Selectable)
4" Baffle



NOXAC-5631 (Dedicated CCT)
NOXAC-5631TW (Selectable CCT)
5"/6" Reflector



NOXAC-5632 (Dedicated CCT)
NOXAC-5632TW (Selectable CCT)
5"/6" Baffle



NOXAC-436
4" Square (Dedicated CCT)



NOXAC-636
6" Square (Dedicated CCT)



NOXAC-5631TWBB
5 1/2" Reflector

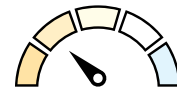

Selectable CCT

Five position sliding switch
27K / 30K / 35K / 40K / 50K

**Now Available in
Dedicated CCT
or Selectable CCT!**



NOXAC-432 / NOX-40R-W
4" Baffle with Oversize Ring



NOXAC-431 / NOX-4EYELIDW
4" Reflector with White Eyelid



NOXAC-436
4" Square

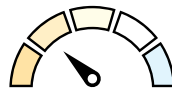
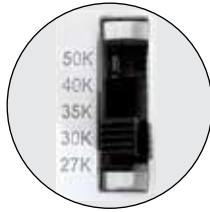

Selectable CCT

Five position sliding switch
27K / 30K / 35K / 40K / 50K



NOXAC-4RGTW
4" Adjustable
800lm



NOXAC-56RGTW
5 7/8" Adjustable
1050lm



Scan for info.

LUMENS: 800lm or 1050lm

COLOR TEMPERATURE: Selectable



AC ONYX ADJUSTABLE

4", 5" and 6" Retrofit Downlights
Selectable CCT (27K/30K/35K/40K/50K)
Compatible with Shallow Housings

AC Onyx adjustable LED retrofit downlights **requires no driver**, compatible with almost all recessed housings. Luminaires tilt up to **40° tilt and 360° rotation**. An integrated **selectable CCT switch** changes the **color temperature (27K / 30K / 35K / 40K / 50K)** and dimmable with compatible Triac or ELV dimmers.

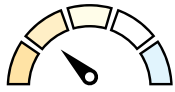

Selectable CCT

Five position sliding switch
27K / 30K / 35K / 40K / 50K

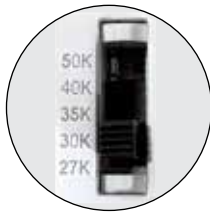

NOXAC-4RWTW
4" Round Wall Wash



NOXAC-4SWTW
4" Square Wall Wash



Scan for info.

LUMENS: 700lm or 800lm

COLOR TEMPERATURE: Selectable



AC ONYX WALL WASH

4" Wall Wash Retrofit
Round or Square Aperture
Selectable CCT (27K/30K/35K/40K/50K)

AC Onyx wall wash LED retrofits **requires no driver**, compatible with most recessed housings, including shallow housings. **Wet location rated** luminaires include an integrated **selectable CCT switch** to change the **color temperature (27K / 30K / 35K / 40K / 50K)** and dimmable with compatible Triac or ELV dimmers.



Scan for info.



LUMENS: 750lm to 1000lm

COLOR TEMPERATURE:

Dedicated or Selectable



COBALT CLICK RETROFIT

4", 5" and 6" Retrofit Downlights Specification Options(0-10V & Emergency)

4", 5" and 6" Cobalt Click LED retrofits deliver **up to 1000 lumen output** and now available in **Dedicated CCT or Selectable CCT**. Cobalt series integrates the latest from the Signify® COB family of LED arrays, giving bright spectacular light output and low power consumption. The deep set lens provides excellent visual comfort, while the UTM design allows the luminaires to be used in shallow housings. The Cobalt Click Series is available in square or round apertures, 0-10V dimming, emergency back-up and 277V input.



New Comfort Dim

3000K down to 2000K
900 lumens!



NLCBC2-451
Round Reflector



NLCBC2-452
Round Baffle



NLCBC2-453
Square Reflector
w/ Round Aperture



NLCBC2-456
Square Reflector
w/ Square Aperture

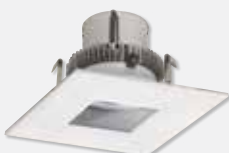

NLCBC2-455
Square Pinhole
(Available in 4" only)



NLCBC2-453TW
4" Square w/
Round Aperture

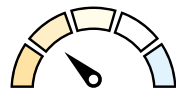

Selectable CCT
Five position sliding switch
27K / 30K / 35K / 40K / 50K

**Now Available in
Dedicated CCT
or Selectable CCT!**

NLCBC2-651TW
6" Reflector



NLCBC2-552TW
5" Baffle



NLCBC2-651TW
6" Round



Medium Base Socket
included with each
luminaire for easy
retrofitting

Patent Nos. D824,568S; D797977S; D871,644S





Patent Nos. D824,568S; D797977S; D871,644S



New Comfort Dim
Warm Dim
(3000K-2000K)



NLCB2-651
6" Reflector



NLCB2-652
6" Baffle



NLCB2-653
6" Square with Round Aperture



NLCB2-656
6" Square Reflector



NHICB-6
IC New Construction



NHRCB-6
Non-IC Remodel



NHCB-6
Non-IC New Construction



Scan for info.

LUMENS: 1500lm or 2000lm
COLOR TEMPERATURE: Dedicated



COBALT HIGH LUMEN

6" Dedicated Downlights
Dedicated CCT and Comfort Dim (Warm Dim)
IC, Emergency and 0-10V dimming options

The 6" **Cobalt High Lumen** provides the same look and color consistency as the popular Cobalt Click downlights using a Signify COB, but producing an incredible **2000+ or 1500 lumens at 90+ CRI**. The series is offered in a wide variety of click-on trims, including square and round apertures in eight finishes. The Cobalt HL is a **dedicated unit, not retrofit, that requires a Nora new construction or remodel non-IC housing**. Available in 120V/277V, 0-10V dimming and emergency configuration, the Cobalt HL works seamlessly with our Cobalt, Cobalt Click, and Cobalt Shallow families providing a color-consistent and aesthetically identical package.



Scan for info.

LUMENS: 1000lm or 1200lm
COLOR TEMPERATURE: Dedicated

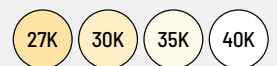

COBALT ADJUSTABLE RETROFIT

4", 5" and 6" Retrofits
30° Adjustment / 358° Rotation
Specification Options (0-10V & Emergency)

4", 5" and 6" **Cobalt Adjustable Retrofit** features a patented design that rotates and adjusts while never exposing an opening or breaking the ceiling plane. The glide mechanism allows for total aiming flexibility while producing up to **1200 lumens at 90+ CRI**. An excellent solution for slope ceilings, luminaires **include field-changeable optics** for spot, narrow flood and flood beam spreads and **optional TIR premium reflectors** available. Choose from six different finishes that matches the complete family of Cobalt downlights.



Patent No. D917,090S

Integral Driver
Triac / ELV dimming

Medium Base Socket
included with each luminaire for easy retrofitting



Field Changeable Optics
Each retrofit includes spot, narrow flood & flood optics



COB LED technology
2700K, 3000K, 3500K or 4000K

Frosted Lens
comes pre-installed and additional semi-frosted lens included

Adjusts up to 30°



NLCBC-469
4" Adjustable



NLCBC-569
5" Adjustable



Rotates 358°
NLCBC-669
6" Adjustable

Scan for info.



LUMENS: 850lm to 1250lm

COLOR TEMPERATURE: Dedicated

27K

30K

35K

40K

COBALT SHALLOW

4" Shallow IC Air-Tight Housing
2-5/8" Height & Delivering 1250 lumens
Phase or 0-10V dimming options

Cobalt Shallow Series allows for installation in over crowded plenums in multi-family or shallow ceiling constructions at **only 2-5/8" height**. The **patented design** allows for access to the driver from below the ceiling. The finished look and deep set optics performs and looks like a standard deep regressed downlight. Available in **850 and 1250 lumens at 90+ CRI** utilizing Cree COB technology, the Cobalt Shallow is the shallowest housing and LED module combination on the market. Choose from eleven different finishes that matches the complete family of Cobalt downlights.



Patent Nos. D877,390S; D824,568S; D797977S; D871,644S

Only 2-5/8" height!



Scan for info.



LUMENS: 800lm

COLOR TEMPERATURE: Dedicated

27K

30K

35K

40K

COBALT ELBOW RETROFIT

4" Round or Square Retrofit
75° Tilt / 358° Rotation
Field Changeable Optics

One of the most flexible lighting tools on the market, the Cobalt Adjustable Elbow retrofit **rotates 358 degrees** horizontally and **adjusts 75 degrees** vertically. Available in round or square and multiple finishes, the Elbow produces **800 lumens at 90+ CRI** in various CCTs. Each Elbow **includes two field-changeable optics** for spot and narrow flood beam spreads. Retrofit luminaires are compatible with most 4" new construction and remodel housings and can be specified with **remote emergency options**.



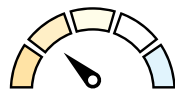

Selectable CCT

Five position sliding switch
27K / 30K / 35K / 40K / 50K



NLRS-611
6" LED Reflector
Selectable CCT



NLRS-612
6" LED Baffle
Selectable CCT



NTM-615
6" Metal Baffle



NTP-614
6" Plastic Baffle



NHIC-926DWQAT
6" Double Wall
Medium Base Housing



NHIC-926QAT
6" Medium Base Housing



NHIC-926QAT
6" Medium Base Remodel

NHIC-926LMRAT
6" LED Dedicated Housing

NHIC-926LMRAT
6" LED Dedicated Remodel



Scan for info.

LUMENS: 1200lm

COLOR TEMPERATURE: Selectable



SLOPED CEILING

6" LED Retrofits, Trims and Housings
Reflector and Baffle Trims
Ceiling pitches from 2/12 to 6/12

Retrofit existing sloped housings with **LED retrofit downlights** that deliver up to **1200 lumens** with **two trim options** and a **selectable color temperature** switch. IC Air-tight sloped ceiling housings are also available in new construction or remodel options that can be adjusted for 2/12 (10°) to 6/12 (26.5°) ceiling pitches. Housings can be specified with a medium base socket or quick connect for LED luminaires. Sloped LED luminaires include a retrofit adapter for new and existing medium base housings.



Scan for info.

LUMENS: 1200lm

COLOR TEMPERATURE: Dedicated



SUPER SLOPED CEILING

6" LED Retrofits, Trims and Housings
Reflector and Baffle Trims
Ceiling pitches from 7/12 to 12/12

Super sloped ceilings' pitches range from 7/12 (30°) to 12/12 (45°) and require a housing with greater angle. Variety of IC air-tight sloped ceiling housings are available with a medium base socket or dedicated for LED luminaires only. Super sloped LED luminaires include a retrofit adapter for new and existing medium base housings. LED luminaires also have dedicated CCT options in 2700K, 3000K or 4000K.



NTM-616/45
6" Reflector



NTM-617/45
6" Baffle



NLRS-6S11
6" LED Reflector



NLRS-6S12
6" LED Baffle



NHIC-928QAT
6" Medium Base Housing

NHIC-928LMRAT
6" LED Dedicated Housing



NHRIC-928QAT
6" Medium Base Housing

NHRIC-928LMRAT
6" LED Dedicated Housing

Scan for info.



LUMENS: 1050lm per foot

COLOR TEMPERATURE:

Dedicated or Selectable

30K

35K

40K

NLIN / NLINSW

120-277V LED Linear System
Surface or Pendant Mounted
2' to 8' Linear and X, L & T Connectors

L-Line Direct LED linear luminaires offer a clean and modern appearance with a sleek extruded aluminum housing. Symmetrical light distribution will evenly illuminate surfaces with a diffused lens, making the L-Line ideal for commercial, retail, healthcare and education applications. Delivering **1050 lumens per foot** in dedicated CCT or selectable CCT options (**3000K, 3500K or 4000K**). Internal quick connects allow systems to be connected with seamless luminous L, X or T connectors.

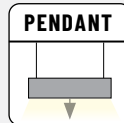
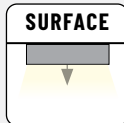
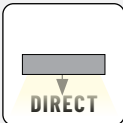

NLIN-PCC
Pendant Mounting Kit

NLINSW-2
2' Linear

NLIN-JBC
Surface Mount Kit



Selectable Lumens

3 Position Sliding Switch
(varies per luminaire)

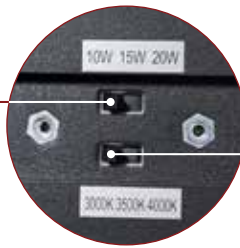

Selectable CCT

3 Position Sliding Switch
3000K / 3500K / 4000K

**Now Available with
Emergency!**



NLINSW-L10
L-Connector



NLINSW-X10
X-Connector



NLINSW-T10
T-Connector

Scan for info.



LUMENS: 1050lm per foot

COLOR TEMPERATURE: Dedicated

30K

35K

40K

NWLIN

120-277V LED Wall Mount
Continuous runs up to 80'
Two Wall Plates Sizes (2"x4" & 4"x4")

L-Line LED wall mount luminaires maintain the same appearance as NLIN luminaires. Symmetrical light distribution will evenly illuminate surfaces with a diffused lens. Maintaining the same internal components as NLIN, luminaires can be daisy chained up to 80'. Delivering **1050 lumens per foot** in dedicated CCT options (**3000K, 3500K or 4000K**). L-Line is ideal for commercial, retail, healthcare and education applications.

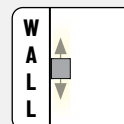
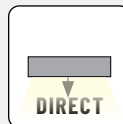

2"x4"
Square Wall Plate

4"x4"
Square Wall Plate

NWLIN-410A/L4P-R2
(2) 4' L-Line Wall Mount
(power feed on left)

Seamless Connection
Hardware included to daisy chain up to 80'

NLUD-PCC
Pendant Mounting Kit

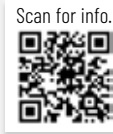

LUMENS: 1643lm per foot
COLOR TEMPERATURE: Selectable

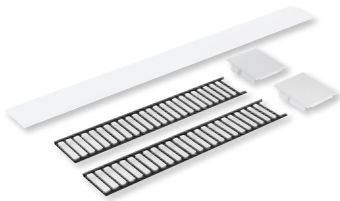

New Options!
Occupance Sensor &
Louver Accessories

NLUD-4334
4' Linear Luminaire

NLUD-4WM
4' Wall Mount Kit

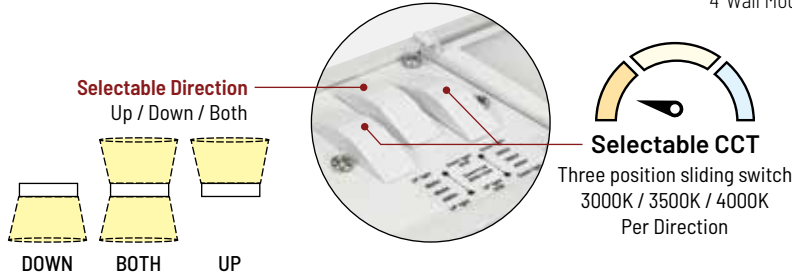

NLUD-L334
L-Connector



NLUD-X334
X-Connector



NLUD-T334
T-Connector

NLUD

120-347V Linear LED Indirect / Direct
Selectable Direction & Selectable CCT
Pendant or Wall Mounted

L-Line LED indirect / direct luminaires include three integral switches for direction of light and selectable color temperature per direction. Sleek extruded housing with symmetrical light distribution will evenly illuminate surfaces with a diffused lens. These pendant or wall mounted fixtures are ideal for commercial, retail, healthcare and education applications. Internal quick connects allow systems to be connected with seamless luminous L, X or T connectors

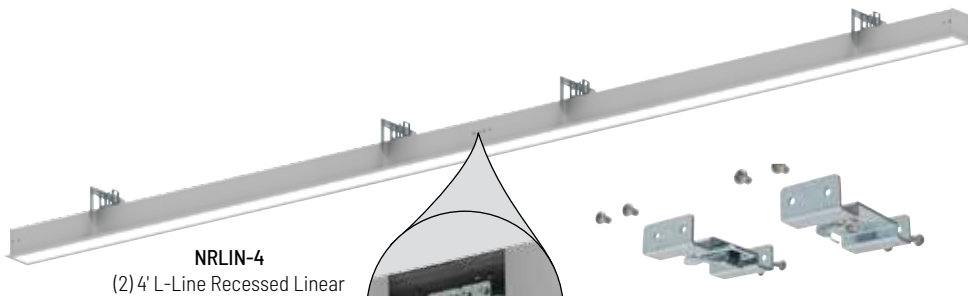
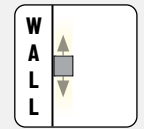
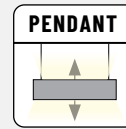
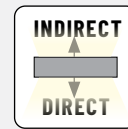

NRLIN-4
(2) 4' L-Line Recessed Linear



NRLIN-BRKT
Brackets for Continuous Runs

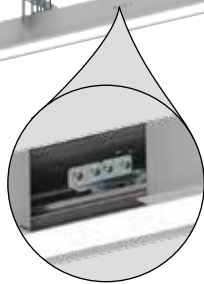

Luminaires can be connected together
with bracket accessory.

**Continuous Lens
now available!**

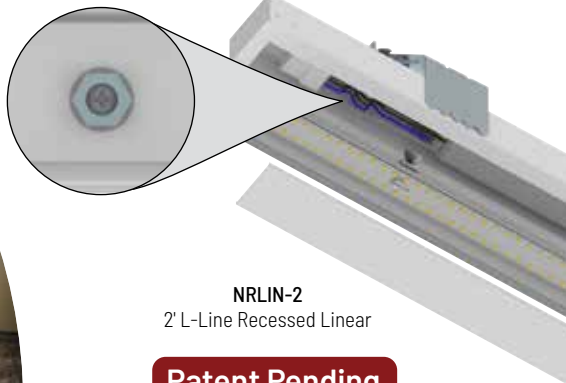

NRLIN-2
2' L-Line Recessed Linear

Patent Pending



LUMENS: 1050lm per foot
COLOR TEMPERATURE: Dedicated



NRLIN

120-277V LED Recessed Linear
Continuous runs up to 80'
2' to 8' Linear Lengths

L-Line LED recessed luminaires maintain the same appearance as NLIN luminaires. Each luminaire includes a finished flange in white or aluminum finish. Maintaining the same internal components as NLIN, luminaires can be daisy chained up to 80'. Delivering 1050 lumens per foot in dedicated CCT options (3000K, 3500K or 4000K). L-Line is ideal for commercial, retail, healthcare and education applications.

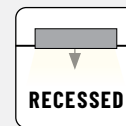
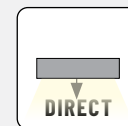

Scan for info.



LUMENS: 1000lm to 2100lm

COLOR TEMPERATURE: Dedicated

27K

30K

40K

ELO SERIES

Four Sizes (6", 8", 11" & 16")
Surface Mount or Pendant Mount (16" only)
Retrofit Kit included (6", 8" & 11" only)

ELO LED Surface mount luminaires are a minimalist appearance. 16" luminaire can be surface mounted over a junction box or suspended with accessories. Smaller luminaires (6", 8" and 11") can also be retrofit over recessed housings with a retrofit kit.



Sloped Canopy

allows for all wires to be enclosed in stem



NELOCAC-11R30W
11" ELO



NELOCAC-6RL130W
6" ELO



NELOCAC-8R30W
8" ELO



NELOCAC-16PKW
Pendant Kit for 16"

NELOCAC-16STW
Stem Kit for 16"



Now Available in Black!

NELOCAC-16R
16" ELO

Scan for info.



LUMENS: 640lm to 1700lm

COLOR TEMPERATURE: Dedicated

27K

30K

35K

40K

50K

ELO+ SERIES

Four Sizes (4", 6", 8" & 11")
Surface Mount or Retrofit (kit included)
Decorative Accessory Rings

ELO+ LED Surface mount luminaires can be surface mounted over a junction box or retrofit into recessed housings. Luminaires includes an integral magnet to seamlessly attach decorative rings. Easily change the finish to match any decor or hardware in the vicinity. ELO+ is available in four sizes and five dedicated color temperatures (2700K, 3000K, 3500K, 4000K or 5000K @ 90+ CRI).



Decorative Rings for ELO+



NELOCAC-4RP
4" ELO+

New Emergency Enclosure!

Battery Backup for 6" ELO



NELOCAC-6RP / NSEM-6WD
6" ELO+ with
Emergency Battery



NELOCAC-8RP / NLOCAC-8RBN
8" ELO+ with Decorative Ring



NELOCAC-11RP / NLOCAC-11RB
11" ELO+ with Decorative Ring





Scan for info.



LUMENS: 1079lm or 1588lm
COLOR TEMPERATURE: Dedicated

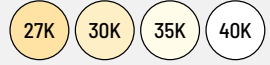

wELO SERIES

120-277V input; 0-10V dimming
 8" and 11" Surface Mount
 Wet Location rated!

wELO surface mount luminaires are 1" thick with a regressed lens. Wet location rated luminaires are designed to surface mount over a standard or fire rated junction box. Available in **8" (1079lm)** and **11" (1588lm)** in dedicated CCT options (**2700K, 3000K, or 4000K**) in a **white finish**. An integral 0-10V drivers accept universal input (**120-277V**). Luminaires are a perfect solution for wet location, multi-family, residential and light commercial applications.



Dedicated CCT
 2700K, 3000K, 3500K, 4000K

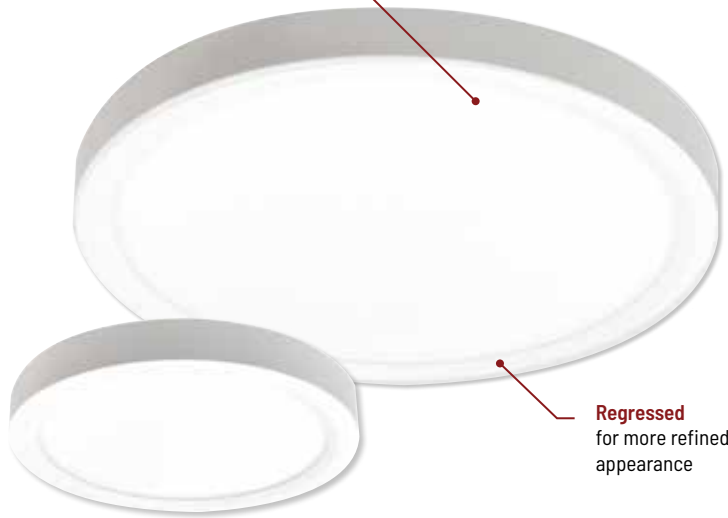

Regressed
 for more refined appearance

Two Sizes & Outputs
 8" or 11" Diameter
 1079lm or 1588lm



NWEL0-8R
 8" wELO
 1079lm / 10W



NWEL0-11R
 11" wELO
 1588lm / 15W



NWEL0-4BKT
 4" Square Junction Box Bracket
 (NWEL0-8R only)

Scan for info.



LUMENS: 750lm to 1150lm

COLOR TEMPERATURE: Dedicated

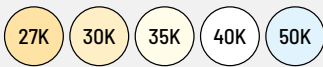

SURF

Three Sizes (4", 6" & 7")
Regressed Baffle with Light Guide
Honeycomb Lens removes glare

SURF Edge-Lit Surface Mount is an aesthetically pleasing luminaire that produces even illumination while reducing glare. The specially designed regressed lens greatly reduces aperture brightness and extends less than 7/8" from the ceiling. Series is available in square and round, 2700K, 3000K, 3500K, 4000K and 5000K temperatures with an architectural elegance for today's specification standards. SURF mounts easily over a standard or fire rated fixture junction boxes.

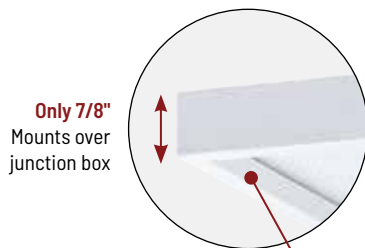

Only 7/8"
Mounts over
junction box

Regressed Baffle
Soft ascending steps



NLOS-S42L
4" Square



NLOS-R42L
4" Round

Light Guide with Honeycomb Lens
Best Surface Mount Eliminates Glare!



NLOS-R72L
7" Round



NLOS-S62L
6" Square



Scan for info.



LUMENS: 700lm to 2150lm

COLOR TEMPERATURE:

Dedicated or Selectable



OPAL

Four Sizes (4", 6", 7" & 8")
Regressed, Motion Sensor or Standard
Surface Mount or Retrofit

AC Opal Series LED fixtures are designed to surface mount over a standard junction box. The low 7/8" profile luminaires are available in 4", 6" and 8" sizes from 700lm to 2150lm in three finishes; 4" and 6" regressed style and 7" 1050lm unit with PIR motion sensor and Selectable CCT. Opal is an excellent energy efficient lighting solution for laundry rooms, closets, pantries, hallways and showers in residential and commercial retrofit or new construction applications.

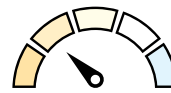

Selectable CCT

Five position sliding switch
27K / 30K / 35K / 40K / 50K



NLOPAC-R4TW
4" Opal
Selectable CCT



Now with Selectable CCT
NLOPAC-R7MSTW
7" Opal with Motion Sensor and
Selectable CCT



NLOPAC-6REGT24
6" Regressed Opal
Dedicated CCT



NLOPAC2-R6509T24
6" Opal 2
Dedicated CCT



NLOPAC-R8T24
8" Opal
Dedicated CCT



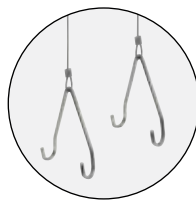

Pendant Kit
Includes 8' Aircraft Cable

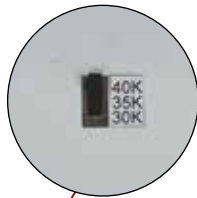

Selectable CCT
Three position switch
3000K / 3500K / 4000K

**Now Available with
Integral Motion Sensor!**



Optional Emergency
Integral Test Switch and Indicator Light

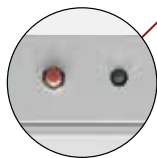

NLSTR
4' or 8' Strip Light

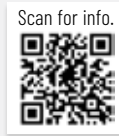

Scan for info.

LUMENS: 3300lm or 8000lm
COLOR TEMPERATURE: Selectable



STRIP LIGHT

Two Sizes (3300lm / 4' or 8000lm / 8')
120-277V input; 0-10V dimming
Emergency & Motion Sensor options

Industrial LED Tunable Strip Light includes an integral CCT switch to change the color temperature at any time! Ideal for commercial, residential, industrial and retail applications. Luminaire's lens is designed to evenly spread the light in a complete 120° beam pattern. The smooth lens makes for easy maintenance and no diode image. NLSTR can be used in storage or utility buildings, coves, display cases, workshops and garages for task and general lighting.

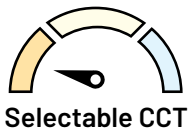

Selectable CCT
Three position sliding switch
3000K / 3500K / 4000K



Selectable Lumens
Three position sliding switch
7000lm / 7500lm / 8000lm

**Pendant Kit
also available!**



NLWPSW-4334W
4' Wraparound



Optional Emergency
Integral Test Switch and Indicator Light

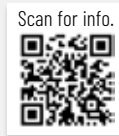

Scan for info.

LUMENS: Selectable (7000lm to 8000lm)
COLOR TEMPERATURE: Selectable



WRAPAROUND

Selectable Lumens & Selectable CCT
120-277V input; 0-10V dimming
Emergency & Motion Sensor options

Industrial LED Wraparound L-Line LED Direct luminaires include two integral switches for lumen output and selectable color temperature. Ideal for commercial, residential, industrial, and retail applications, such as; stairwells, hallways, garages, schools, offices, and more. Easy to install and great for replacing outdated fluorescents with an energy efficient, cost saving alternative. The luminaire's lens is designed to uniformly spread and soften the appearance of the light while maximizing its distribution and output.



Scan for info.



LUMENS: 3000lm (1500lm per direction)

COLOR TEMPERATURE: Selectable



WALL MOUNT CYLINDER

3" Outdoor Rated Cylinder

Selectable Direction (Up / Down / Both)

Selectable CCT (3000K / 4000K / 5000K)

Architectural grade ADA compliant up-and-down wall mount cylinder with two dedicated COB LEDs mounted in the up and down position. Each cylinder includes two integral switches to change the direction of light and color temperature after installation. IP65 and wet location rated for most indoor and outdoor applications. Powder coated in three architectural finishes (bronze, black or matte powder white).



NYUD-3L1345B
Black Finish



NYUD-3L1345BZ
Bronze Finish



NYUD-3L1345MPW
Matte Powder White Finish



Selectable CCT
Three position switch
3000K / 4000K / 5000K

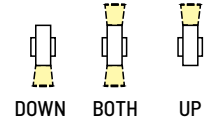

Direction of Light
Down / Both / Up



2" iLENE accepts Cone Accessory!



NYLM-2CONE
2" Cone Accessory



NYLM-2C
2" Cable



NYLM-3ST
3" Stem



NYLM-5ST
5" Stem



NYLM-2SC
2" Surface



NYLM-3SC
3" Surface



NYLM-5SC
5" Surface

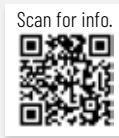

Scan for info.

LUMENS: 1000lm to 2000lm

COLOR TEMPERATURE: Dedicated

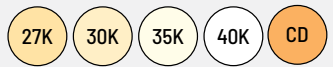

iLENE™ MINI CYLINDERS

Three Sizes (2", 3" & 5")
Surface, Stem or Cable Mounted
Architectural Die-Cast Finishes

iLENE LED Mini Cylinders consists of three sizes, multiple finishes and is offered in a surface, stem or cable mounted. Using Cree COB or Comfort Dim technology the cylinders produce 1000lm (2"), 1500lm (3") or 2000lm (5"). Each iLENE cylinder includes three field changeable optics for maximum design control. Optional accessories can further customize the fixtures.

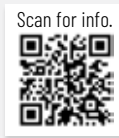

Scan for info.

LUMENS: 750lm to 5500lm

COLOR TEMPERATURE: Dedicated

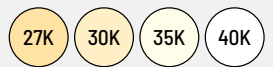

6" CYLINDERS

Surface, Stem, Cable or Wall Mounted
Ten Architectural Finishes
Specifiable Beam Spreads

6" Cylinders are available in three different series: Sapphire III (up to 5500lm w/ specifiable beam spreads), Cobalt (up to 1000lm) and Medium Base Incandescent/LED. Each cylinder has four different mounting types for any application; Cable mounted includes 8' cable, Wall mount is Wet Location rated, Surface mounted or Stem mounted with new sloped canopy.



NYLD2-6S
Surface Mounted



NYLS3-6P
Stem Mounted



NYLS3-6C
Cable Mounted



NYLI-6W
Wall Mounted



Sloped Canopy
allows for all wires to be enclosed in stem



Scan for info.



LUMENS: 1200lm to 3800lm

COLOR TEMPERATURE: Dedicated

30K

35K

40K

RLM SHADES

Three Sizes (8", 10" & 16")

120/277V input; Phase or 0-10V dimming

Three Finishes (White, Gun Metal, Black)

Aluminum spun shades with built-in dimmable driver and LED COB technology provide excellent general illumination. The optics are set deep inside the shades for visual comfort while producing **up to 2200 lumen (8"), 3000 lumen (10") or 3800 lumens (16") at 90+ CRI.** Shades' exterior finishes include: white, black and gun metal with reflective white interior bowls. Dedicated color temperature include **3000K, 3500K and 4000K,** the shades are a perfect solution for retail, commercial, and hospitality applications.



NRLM-10ST
10" Shade
Stem Mounted



NRLM-8C
8" Shade
Cable Mounted



NRLM-16C
16" Shade
Cable Mounted



Scan for info.



LUMENS: 2600lm to 5700lm

COLOR TEMPERATURE:

Dedicated 5000K or Selectable

30K

35K

40K

50K

BACKLIT PANELS

Three Sizes (1'x4', 2'x2' & 2'x4')

Selectable Lumens and Selectable CCT

Lay-In, Surface, Recessed or Cable Mounted

LED Panels produce uniform, glare-free illumination in offices, conference rooms, libraries and other task areas where general illumination is desired. Backlit panels include a **field selectable CCT switch** which allows the luminaire to be switched (3000K / 3500K / 4000K) or **dedicated 5000K.** LED Panels are available in three sizes: **2' x 2', 1' x 4' and 2' x 4',** which can be installed in most grid ceilings. Optional mounting accessories are available for surface mounting, recessed mounting into hard ceilings or pendant mounting. Emergency options are also available, along with **new integral motion sensor.**



Selectable Lumens
Three position sliding switch



Selectable CCT
Three position sliding switch
3000K / 3500K / 4000K

**Now Available with
Integral Motion Sensor!**



NPDBLSW-E22 (3500lm)
NPDBLSW-E22 (Selectable Lumens)
2' x 2' Panel



NPDBLSW-E14 (3500lm)
NPDBLSW-E14 (Selectable Lumens)
1' x 4' Panel



NPDBLSW-E24 (5700lm)
NPDBLSW-E24 (Selectable Lumens)
2' x 4' Panel



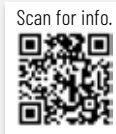

LUMENS: Selectable (4000lm to 6950lm)

COLOR TEMPERATURE: Selectable



FRAME LIGHT

Two Sizes (2'x2' & 2'x4')
 Selectable Lumens & Selectable CCT
 One Piece Construction - No Assembly!

LED Frame lights are a perimeter fixture for standard ceiling grids. Existing ceiling grid will sit inside the frame light, **no cutting required**. Perfect solution for commercial applications such as conference rooms, libraries and offices. **One piece construction and ready to be installed out of the box**, compared to competitors which require each fixture to be assembled. Luminaires include two **field selectable CCT switches** for color temperature and brightness. Universal input (120-277VAC) and dimmable with compatible 0-10V dimmers.

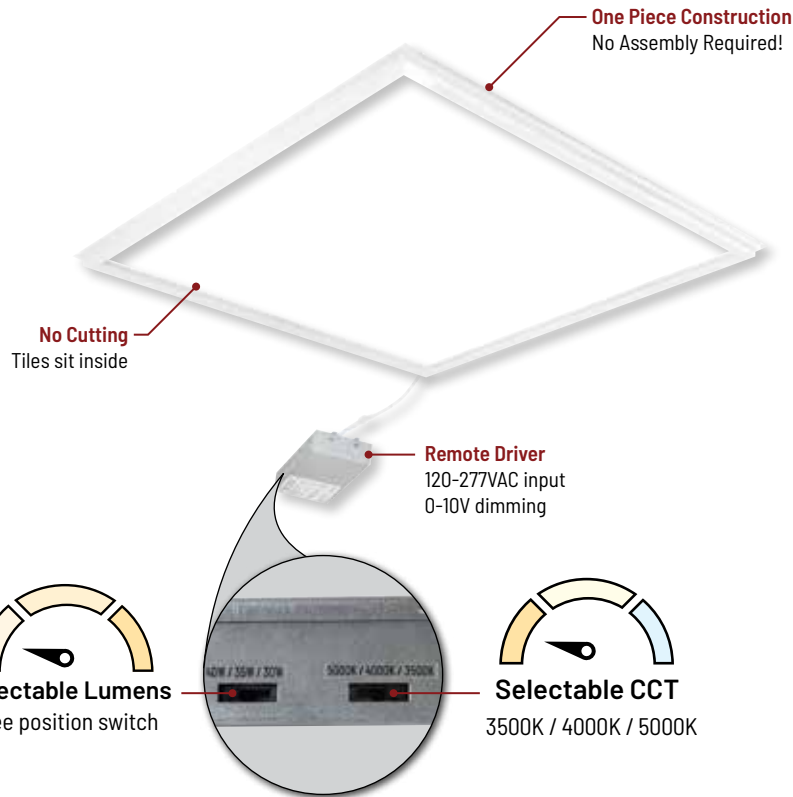

NPTPSW-E22
 2' x 2' LED Frame Light
 (4000lm to 5000lm)



New Size!
NPTPSW-E24
 2' x 4' LED Frame Light
 (5850lm to 6950lm)

Scan for info.



LUMENS: 1600lm or 3200lm

COLOR TEMPERATURE: Selectable

30K

35K

40K

T-LINE TRACK

Linear Track Head with Selectable CCT
Two Sizes (23" / 1600lm or 45" / 3200lm)
Field Changeable Lenses & Accessories

T-Line is a unique LED linear track head with field changeable lenses to change the light distribution. Track heads are available in two lengths and lumen outputs; 1600lm (2') or 3200lm (4') for general illumination and combine it with directional track heads for a perfect solution to retailing or retrofitting existing track with energy efficient LED light. T-Line features a selectable CCT switch using dip switches in the end of each track head, which can be set at 3000K, 3500K or 4000K. T-Line comes standard with a frosted symmetrical lens, asymmetric lenses and visor are available for aisle lighting or directional lighting.

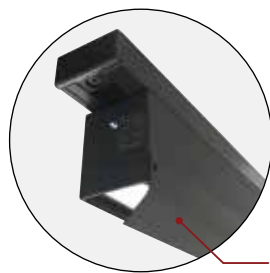

Visor Accessory
Use with asymmetric lens for wall washing



NTE-LIN2TW (23")
NTE-LIN4TW (45")
T-Line



Selectable CCT

Three position sliding switch
3000K / 3500K / 4000K



Scan for info.



LUMENS: 1450lm

COLOR TEMPERATURE: Selectable

30K

35K

40K

JASON PS TRACK

Selectable CCT (3000K / 3500K / 4000K)
Specifiable Beam Spread
Optional Accessories

Jason PS LED track heads feature an integral color temperature switch, allowing the end user to change the color temperature. Luminaire delivers **1450 lumens** in three color temperatures (**3000K / 3500K / 4000K**) @ **90 CRI**. Track heads can be specified in **spot, narrow flood or flood beam spread** to create the ideal cone of light per application. Jason track heads include a clear glass and accept a variety of accessories ranging from **barndoors, snoot, shield or louver**. Making this series ideal for residential to commercial applications to compliment any space.

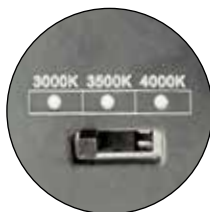

Selectable CCT

Three position sliding switch
3000K / 3500K / 4000K

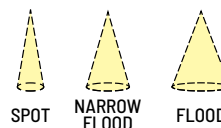

Specifiable Beam Spreads
Spot, Narrow Flood and Flood

NTE-856
Jason PS





NTE-875L9CDX
MAC XL Comfort Dim



NTE-870L
MAC

NTE-875L
MAC XL

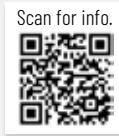

Scan for info.

LUMENS: 800lm to 1250lm
COLOR TEMPERATURE: Dedicated



MAC TRACK

AC LED – No Driver!
Dedicated CCT or Comfort Dim
Field Changeable Optics

MAC LED Track heads have an eclectic style to fit any decor. Luminaire features **COB LED technology** allowing for better optic control and include two **field changeable optics (spot or flood)**. MAC delivers **800 lumens** and MAC XL delivers **1250 lumens** in **2700K, 3000K, 3500K or 4000K** at 90+ CRI. **Comfort Dim (warm dimming)** option now available for MAC XL. AC LED allows for no driver to maintain a small appearance in **white, black or silver** finishes. Track adapters can be converted to J and L style adapters.



Warm Dim Option
Color temperature warms as luminaire is dimmed

NTE-860
MAY



Specifiable Beam Spreads
Spot, Narrow Flood and Flood
(Note: NTE-864 includes narrow flood only)



NTE-864
MAX Mini

NTE-865
MAX

NTE-866
MAX XL

Scan for info.



LUMENS: 650lm (Comfort Dim) or 850lm (Dedicated)
COLOR TEMPERATURE: Dedicated



Scan for info.



LUMENS: 1000lm to 3650lm
COLOR TEMPERATURE: Dedicated



MAY TRACK

AC LED – No Driver!
850lm • Dedicated CCT or Comfort Dim

May LED Track heads offer clean, modern style for any application. Track heads feature AC LEDs that require no driver, allowing for minimalist appearance. May luminaires deliver up to **850 lumens** at **2700K, 3000K, 3500K or 4000K** @ 90 CRI. **Comfort Dim (warm dimming)** option warms the color temperature from **2900K to 1800K** as the fixture is dimmed. Track heads include a **narrow flood optic** and available in **black or white** finishes. May Track heads are certified to the high efficacy requirements of California Title 24. Track adapters can be converted to J and L style adapters.



MAX TRACK

Three Sizes and Three Outputs
Specifiable Beam Spreads
Three Sizes • Premium TIR optics

MAX LED Track heads features **COB LED technology** allowing for better optic control and **premium TIR optics (spot, narrow flood or flood)**. Track heads are available in three sizes and lumen outputs (**1000 to 3650 lumens**) in **2700K, 3000K, 3500K or 4000K** at 90+ CRI. Cylindrical design allows is ideal for higher ceilings and commercial applications in **white, black or silver** finishes. Track adapters can be converted to J and L style adapters.

Scan for info.



LUMENS: 37lm to 86lm

COLOR TEMPERATURE: Dedicated

30K

40K

ARI STEP LIGHTS

Three Face Plate Styles
Fits into a Single Gang Switch Box
Screwless Clean Appearance

The aesthetically pleasing 2.5W or 5W ARI LED step light directs light onto the surface below while shielding the LED source from view. Ari face plates include **vertical, horizontal or interchangeable face plate**, in **matte powder white, brushed nickel or deep bronze finish**. Available in **3000K or 4000K @ 90 CRI**. Long lasting, low maintenance, energy efficient LED step lights provide illumination for safety around steps, balcony areas, or walkways while saving over 80% in running costs when compared to 10W incandescent step lights.



NSW-720
Interchangeable Face Plate



NSW-730
Vertical Face Plate



NSW-740
Horizontal Face Plate



NMP-LED (12V)
NMP2-LED (24V)
Fixed



NMP-A / NMP-AREC (12V)
NMP2-A / NMP-AREC (24V)
Adjustable with Recessed Flange

Scan for info.



LUMENS: 300lm

COLOR TEMPERATURE: Dedicated

27K

30K

35K

40K

JOSH LED PUCK

12V or 24V input & Dimmable
Recessed or Surface Mounted
18° Adjustable or Fixed Puck Light

Josh LED puck lights can be **surface or recessed mounted** with an included finished collar. **12V or 24V Dimmable LED** luminaires produces up to **300 lumens with 2700K, 3000K, 3500K or 4000K**. Each luminaire includes a frosted lens to eliminate hot spots generated by direct view LEDs, which reflects on surfaces. Josh is available in **black, bronze, brushed nickel or white** finishes.



Selectable CCT

Three position sliding switch
3000K / 4000K / 5000K



Adjust up to 90°



NUDTW-98
Bravo FROST with
Selectable CCT

Scan for info.



LUMENS: 850lm per foot

COLOR TEMPERATURE: Selectable

30K

35K

40K

BRAVO FROST TW

120V LED Linear with Selectable CCT
Four Sizes (12", 16", 24" & 32")
90° Adjustable Brackets included

Low profile Bravo FROST TW (**Selectable CCT**) LED linear luminaires offer a **diode image-free** solution for residential and commercial use. Less than 1" in depth, Bravo FROST TW fixtures can be installed under cabinets, within shelves/displays and architectural coves. Bravo FROST TW offers **850 lumens / 10W per foot** with a **selectable CCT switch** which can be set at **3000K, 3500K or 4000K**. Each fixture includes adjustable mounting brackets that adjust the luminaire up to 90° and **lengths range from 12" to 32"**. An encapsulated 120V dimmable LED driver in each unit allows extended runs and easier installation with **3-wire system**.



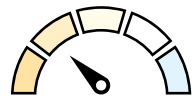

Selectable CCT

Five position sliding switch
27K / 30K / 35K / 40K / 50K



3 Position Switch
Selectable Lumen Output
and turns fixture On / Off



Scan for info.

LUMENS: 475lm per foot
COLOR TEMPERATURE: Selectable



LEDUR TW

120V LED Undercabinet with Selectable Lumens
Five Lengths (11", 18", 22", 32" & 42")
5 CCT options and 2 Outputs in One Fixture!

LEDUR TW allows the end user to **select between five CCT options (27K / 30K / 35K / 40K / 50K) and two outputs (regular or high output) all in one luminaire!** Each undercabinet fixture includes two switches to control each option separately. **Lengths range from 11" to 42" in bronze or white finish.** Edge-lit LEDs **eliminates the diode image** and provides uniform reflectance of light without the hot spots generated by direct view mounted LEDs, which reflects in granite and other mirror-finish counter tops. LEDUR provides smooth, uniform light across the counter surface. Utilizing the same construction and easy installation with captive screws under removable cap. Completely **dimnable and linkable**, the LEDUR is a perfect solution for energy efficient lighting.



NPSU
Class 2
Dimmable Drivers

Scan for info.



INPUT: 110-277V input
OUTPUT: 12V or 24V
DIMMING: Triac, ELV, MLV, 0-10V or PWM



NATL-SWEX60 (60W)
NATL-SWEX100 (100W)
NEXUS

Scan for info.



INPUT: 120V input
OUTPUT: 12V or 24V
DIMMING: Built-In

5-IN-1 DRIVERS

Compatible with 12V or 24V Systems
60W, 96W or 288W (3 x 96W Channels)
Five Dimming Protocols in One

Constant voltage drivers are available for **12V or 24V** under cabinet and linear systems. **Five dimming protocols** (Triac, ELV, MLV, 0-10V, PWM) **within one driver.** Dimmable down to 1% with over-current, over-voltage and temperature protection. NEMA 4X enclosure is rated for **wet locations.**



NEXUS®

LED Driver and Dimmer All-In-One
Compatible with 12V or 24V Systems

The NEXUS all-in-one LED driver and dimmer eliminates compatibility issues by combining an **LED dimmer switch and power supply in one integrated unit.** NEXUS mounts in a standard in-wall switch box and fits a standard Decora switch plate. The unit is **available in 12V or 24V 60W and 24V 100W,** provides 100% to 5% dimming, converts 120V AC to DC low voltage. A white face plate is included, and an optional face plate kit with black, brown and almond plates are available.



Scan for info.



LUMENS: 525lm per foot

COLOR TEMPERATURE: Dedicated

27K

30K

40K

NULS-LED

120V LED Linear

Four Lengths (11", 21", 33" & 45")

Dedicated CCT • 80+ CRI

NULS LED undercabinet produces over **525 lumens per foot** while consuming only **5W** and is available in **2700K, 3000K or 4000K**. 120V input voltage **eliminates the need for any drivers** and wattage concerns. Luminaires can be **connected together seamlessly** or with cable accessories. Each system can be **hardwired into a junction box and dimmed**. Ideal for under cabinet, in cabinet, cove, display, general commercial, retail and residential lighting applications.



3-wire system meets most code requirements

Available in four different lengths
11", 21", 33" and 45"



Side View



NULS-LED
120V LED Linear

Mounting brackets and coupler are included (NULSA-MTGKIT)



Scan for info.



LUMENS: 200lm per foot

COLOR TEMPERATURE: 3000K

30K

120V LIGHTBAR

120V LED Linear

Four Lengths (6", 12", 24" & 48")

Internal Magnets for Easy Mounting

120V LED Lightbar creates an uniform seamless line of light, with internal magnets for easy installation. Producing 200 lumens per foot with a dedicated 3000K, lightbar is a perfect solution for under cabinet, in cabinet, cove, display, and task applications. Variety of connectors and accessories allows luminaires to be connected together up to 40'.



Mounting brackets and end-to-end connector included

Side View

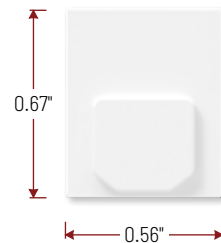

Available in four different lengths
6", 12", 24" and 48"



NULB120
120V LED Lightbar



NX-603D-LED/B
Black Housing

Two Colors in One!



NX-603D-LED
White Housing

LED EXIT SIGN

Dual Color LED Exit Sign with Battery Backup
Selectable Color Switch (Red / Green)

Slim profile universal exit sign includes an **internal switch to change the color of LEDs** to red or green. Mounting hardware can be repositioned for wall, end or ceiling mount applications. Each luminaire includes an emergency battery to keep the exit sign illuminated for 90 minutes during a power outage.



NX-617

NEX-720

NE-970

WET LOCATION

Exit & Emergency

Wet Location LED exit and emergency lights include self diagnostic tests with notification of any failures or malfunctions. Each exit sign includes an optional second face. Long lasting LED sources without maintenance for egress lighting where splashing, non-corrosive liquids and dripping may occur.



NE-700LEDRC

DUAL HEAD

LED Emergency Light w/Remote Capability

Mini profile LED emergency light with remote capability and self diagnostics. Two adjustable 100lm heads include an extra 3.6V battery for 3W remote capabilities. Available in black or white finish and wet location / vandal resistant enclosure.

NX-612LEDB
Black Housing

NX-612LEDW
White Housing



COMPACT DUAL HEAD

Luminaire provides 90 minutes of light from two adjustable heads upon power failure. Available in standard, remote capability, and self diagnostic options. ABS housing with UL 5VA flame rating.

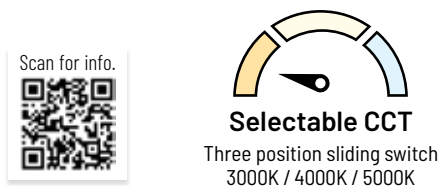

Selectable CCT
Three position sliding switch
3000K / 4000K / 5000K

OUTDOOR EMERGENCY

Outdoor decorative light with dual functions (**general illumination and emergency lighting**). During normal operation, the luminaire will operate with integral photosensor (dusk til dawn) **delivering 1250 lumens**. During emergency operation, an internal battery will operate the luminaire for 90 minutes, **delivering 400 lumens for egress illumination**.



NE-921LEDBCC
Black Housing

NE-921LEDBZCC
Bronz Housing

NE-921LEDWCC
White Housing

Scan for info.



LUMENS: 80lm to 450lm per foot

COLOR TEMPERATURE: Dedicated

27K

30K

42K

CONTINUOUS ROLLS

24V Tape Light Rolls with Flip Connectors
Three Types (Standard, Hy-Brite, High Output)
Field Cuttable Every 4"

Continuous LED tape are available in three outputs:

- **Standard Output: NUTP71**
80lm / 1.5W per foot
100' or 20' rolls
64' maximum run length
- **Hy-Brite: NUTP51**
375lm / 4.25W per foot
100' or 20' rolls
25' maximum run length
- **High Output: NUTP81**
450lm / 6.5W per foot
20' or 16' rolls
16' maximum run length



Flip connectors easily connect
taape without soldering



NUTP71



NUTP51



NUTP81



Now with Surge Protection!



NUTP13

Scan for info.



LUMENS: 330lm per foot

COLOR TEMPERATURE: Dedicated

27K

30K

40K

120V IP65 TAPE LIGHT

120V Tape • Hardwired or Cord & Plug
Factory Cut and Sealed with IP65 Rating
Surge Protector and Mounting Accessories

IP65 rated LED Tape Light is perfect solution for indoor or outdoor applications without the need for LED drivers. Producing **330 lumens per foot** at **2700K, 3000K or 4000K** @ 90+ CRI. Tape is specified per length and factory installed with cord and plug or hardwired with TRIAC dimming. 120V input voltage **eliminates the need for any drivers** and wattage concerns.

Scan for info.



ALUMINUM CHANNELS

4' Lengths and Field Cuttable

Variety of aluminum Channels for the LED Tape lights can be used to hold the tape in visible applications or can be used to hide or conceal the tape in other applications. Offered in 4' shallow and deep sizes, **three finishes**, with or without wings the channels are field cuttable. The unique "J" shape can be used to conceal tape in an under cabinet, book case or framing application. The "J" can even create an instant cove for accent lighting. Use the deep channel with wings to mount in a cabinet or wall to create visual interest or a small, slim line of usable light. Channels without wings are now available in black and white finishes.



NATL-C23A
Recessed
Shallow

NATL-C24A
Shallow

NATL-C25A
Recessed
Deep

NATL-C26W
Deep



NATL-C27A
J-Style

NATL-C28B
Corner

NATL2-C23A
Recessed
Shallow

NATL2-C24A
Shallow



NATL2-C25A
Recessed
Deep

NATL2-C26W
Deep



- NUTP14 Dedicated CCT (HO)
- NUTP15 Dedicated CCT (Standard)
- NUTPCOB RGBW

Cuttable every
1.79" (CCT) or
1.31" (RGBW)

Tape Width:
0.39" (CCT)
0.47" (RGBW)



Scan for NUTPCOB
(RGBW)

NATL2-C29W
Trimless Channel for
NUTP14 & NUTP15



Scan for info.



LUMENS: 210lm or 450lm per foot
COLOR TEMPERATURE: Dedicated



Scan for info.



LUMENS: 300lm per foot
COLOR TEMPERATURE: RGBW with Dedicated 3000K Diode



COB TAPE LIGHT

24V Tape • 16.4' or 100' Rolls
Field Cuttable Every 1.79"
New Terminal Block Accessories

24V COB LED Tape Light creates an uniform seamless line of light, without the need for additional diffused covers or accessories. Available in two outputs (**210 or 450 lumens per foot**) with Dedicated CCT (**2700K, 3000K, 3500K or 4000K**) @ 90+ CRI. Terminal block accessories are now available for power feeds or jumper cables for easy installation. Tape light is a perfect solution for low clearance or reflective surfaces to eliminate all glare or dotting.

RGBW COB TAPE LIGHT

24V Tape • 16.4' Roll
Field Cuttable Every 1.31"
Color Changing LEDs with Dedicated 3000K

24V RGBW COB Tape Light has alternating LED diodes that are RGB and White. Users can create any color in the rainbow using a compatible RGBW controller or DMX decoder. Producing up to **300 lumens per foot** and field cuttable every 1.31". A variety of accessories and channels are available for any application (cove, under cabinet, toe kick, etc.)



NORA LIGHTING, INC.

6505 Gayhart St.
Commerce, CA 90040
TEL 323.767.2600
FAX 323.722.3677
www.NoraLighting.com

DOMESTIC FACILITIES:

Cincinnati, OH
Dallas, TX
Detroit, MI
Edison, NJ
Los Angeles, CA
Louisville, KY
Minneapolis, MN
Nashville, TN

INTERNATIONAL SALES:

6505 Gayhart St.
Commerce, CA 90040
TEL 323.767.2600
FAX 323.722.3677

The products shown in this catalog
are covered by USA and International
patents. Specifications subject to
change without notice.

© Copyright 2025 Nora Lighting, Inc.
All rights reserved